

 ADRIANA HOYOS

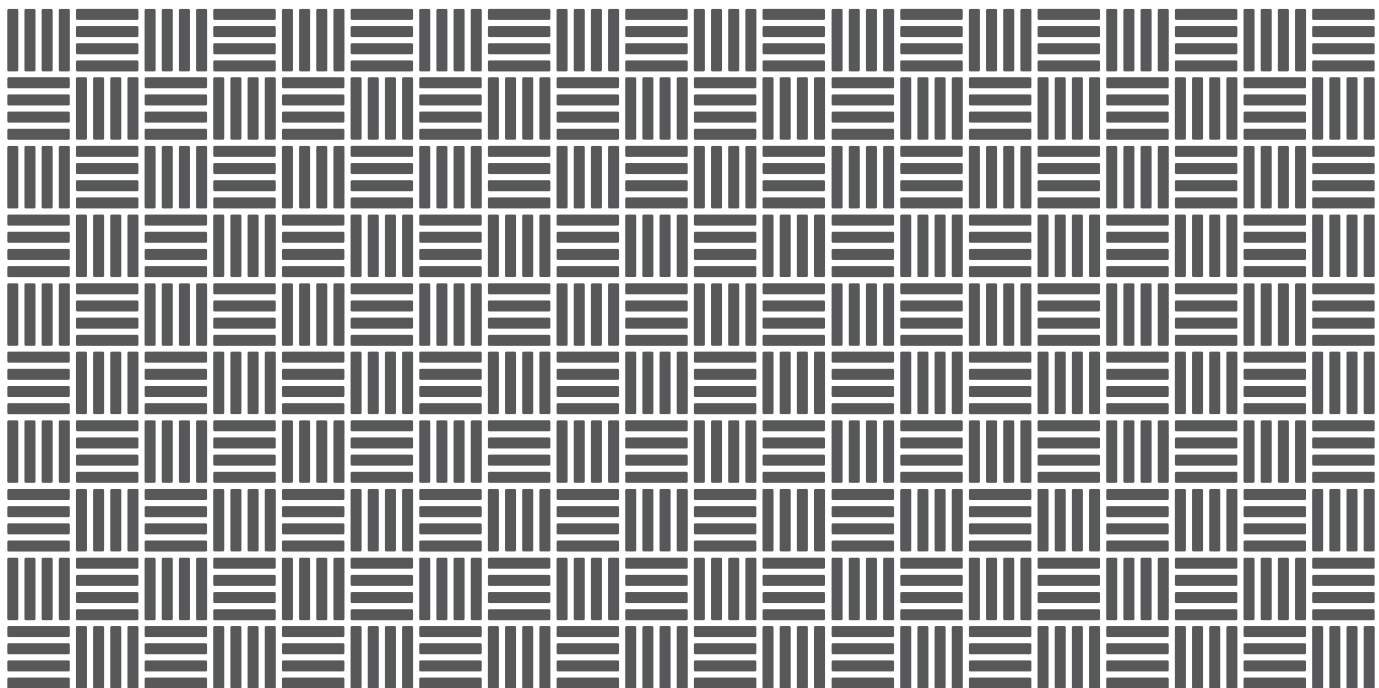

2022 | 2023 CATALOG



Adriana Hoyos & Andrea Pérez Hoyos

“We design to connect lifestyle and luxury,
where sophistication is the real essence.”

Adriana Hoyos.

Index

LIVING ROOM | SALA

Sofas & Loveseats | Sofás y Loveseats
Sectionals | Seccionales
Upholstered Chairs | Poltronas
Ottomans | Otomanes
Daybeds | Daybeds
Cocktail Tables | Mesas Centrales
End Tables | Mesas Auxiliares
Consoles | Consolas

DINING ROOM | COMEDOR

Tables | Mesas
Chairs | Sillas
Bar & counter stools | Bar y counter stools
Buffets | Aparadores

BEDROOM | DORMITORIO

Beds | Camas
Nightstands | Veladores
Dressers | Cómodas

OCCASIONAL PIECES | PIEZAS OCASIONALES

Entertainments | Centros de Entretenimiento
Bookcases & Desks | Libreros y Escritorios
Mirrors | Espejos
Accent Pieces | Piezas de Acento

LIVING ROOM | SALA



SOFAS & LOVESEATS

sofás y love seats



AH SIGNATURE QUILTED SOFA 100
sofá capitoneado ah signature 100



CAMELO QUILTED SOFA 140
sofá capitoneado caramelo 140



GEM SOFA 100
sofá gem 100



GEM SOFA 110
sofá gem 110



GEM SOFA 200
sofá gem 200



GEM SOFA 210
sofá gem 210



GALAPAGOS SOFA 100
sofá galápagos 100



GALAPAGOS SOFA 200
sofá galápagos 200



GALAPAGOS SOFA 210
sofá galápagos 210



GALAPAGOS SOFA 400
sofá galápagos 400

SOFAS & LOVESEATS

sofás y love seats



GRAFITO SOFA / LOVESEAT 100
sofá / love seat grafito 100



GRAFITO SOFA 130
sofá grafito 130



LOVESEAT GRAFITO 200
grafito love seat 200



H SOFA 100
sofá h 100



H SOFA / LOVESEAT 210
sofá / love seat h 210



H SOFA 500
sofá h 500



RUMBA CRESCENT SOFA 100
sofá rumba 100



RUMBA SOFA 200
sofá rumba 200



TEN SOFA / LOVESEAT 110
sofa / love seat ten 110

Slight color variations may occur while printing tear sheets due to printers pixelation and quality. Product specifications are subject to change due to product development updates. / Ligeras variaciones de color pueden ocurrir en la impresión. Las especificaciones están sujetas a cambios debido a las necesidades del producto.

Dimensions are usually approximated to the nearest quarter inch that will correspond to its metric conversion. / Las medidas generalmente se dan de acuerdo a la conversión métrica correspondiente y con una medida aproximada.

Slight color variations may occur while printing tear sheets due to printers pixelation and quality. Product specifications are subject to change due to product development updates. / Ligeras variaciones de color pueden ocurrir en la impresión. Las especificaciones están sujetas a cambios debido a las necesidades del producto.

Dimensions are usually approximated to the nearest quarter inch that will correspond to its metric conversion. / Las medidas generalmente se dan de acuerdo a la conversión métrica correspondiente y con una medida aproximada.

**AH SIGNATURE
QUILTED SOFA 100**
sofá capitoneado
ah signature 100

AH12-100

w 110^{1/4"} D 41^{1/4"} H* 33" SH 16^{1/2"}
280 cm 105 cm 84 cm 42 cm

SW 83^{3/4"} SD 25^{1/2"} AH 29^{1/4"}
213 cm 65 cm 74 cm

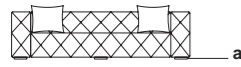
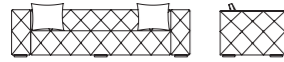
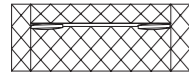

a: wood finish

BACK PILLOWS (X2) / COJINES DE ESPALDAR (X2)

w 23^{1/2"} D 1^{1/2"} H 23^{1/2"}
60 cm 4 cm 60 cm



Wood finish / Acabado madera



**CARAMELO
QUILTED SOFA 140**
sofá capitoneado
caramelo 140

CM12-140

w 96^{1/2"} D 36^{1/2"} H 25^{1/2"} SH 17^{3/4"}
245 cm 93 cm 65 cm 45 cm

SW 17^{3/4"} SD 25^{1/2"} AH 25^{1/2"}
190 cm 65 cm 65 cm

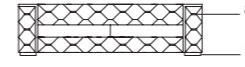
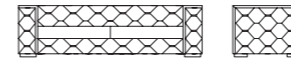
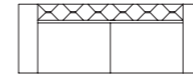

a: decorative plate b: wood finish

Wood finish / Acabado madera

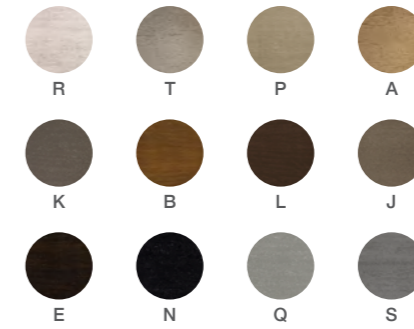

Decorative plate / Placa decorativa

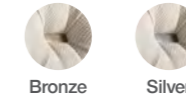

Back pillows included. / Incluye cojines de espaldar.

* (H) Dimensions does not include back pillows. / * (H) Las dimensiones no incluyen los cojines de espaldar.

GEM SOFA 100
sofá gem 100

GM12-100

w 94^{1/2}" D 39^{1/4}" H 37^{1/2}" SH 17^{3/4}"
240 cm 100 cm 95 cm 45 cm

sw 78" SD 27^{1/2}" AH 30"
198cm 70 cm 76 cm

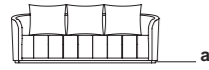
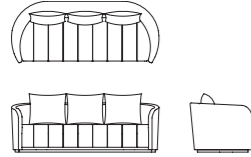

a:wood finish

BACK PILLOWS (X3) / COJINES DE ESPALDAR (X3)

w 23^{1/2}" H 21^{3/4}"
60 cm 55 cm

Wood finish / Acabado madera



GEM SOFA 110
sofá gem 110

GM12-110

w 118" D 39^{1/4}" H 37^{1/2}" SH 17^{3/4}"
300 cm 100 cm 95 cm 45 cm

sw 104" SD 27^{1/2}" AH 30"
264 cm 70 cm 76 cm

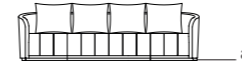
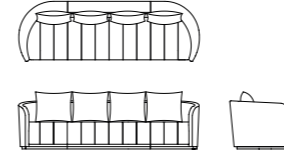

a:wood finish

BACK PILLOWS (X4) / COJINES DE ESPALDAR (X4)

w 23^{1/2}" H 21^{3/4}"
60 cm 55 cm

Wood finish / Acabado madera

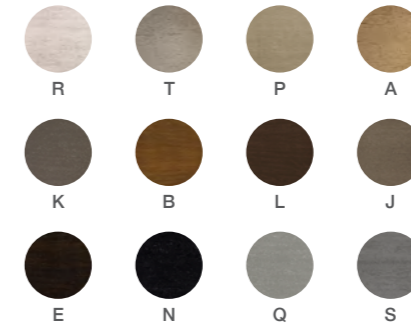

Back pillows included. / Incluye cojines de espaldar.

LIVING ROOM | SALA

Back pillows included. / Incluye cojines de espaldar.

LIVING ROOM | SALA



Referential photo. Some products, finishes or fabrics may no longer be available. /
Foto referencial. Algunos productos, acabados o telas podrían ya no estar disponibles.

GEM SOFA 200
sofá gem 200

GM12-200

W 94^{1/2"} D 37^{3/4"} H 33" SH 17"
240 cm 96 cm 84 cm 43 cm

SW 78^{3/4"} SD 22^{3/4"} AH 26^{3/4"}
200 cm 58 cm 68 cm

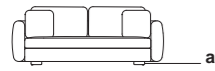
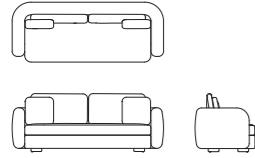

a: wood finish

DECORATIVE PILLOWS (X2) / COJINES DECORATIVOS (X2)

W 17^{3/4"} D 1^{1/2"} H 17^{3/4"}
45 cm 4 cm 45 cm



Wood finish / Acabado madera



GEM SOFA 210
sofa gem 210

GM12-210

W 94^{1/2"} D 37^{3/4"} H 33" SH 17"
240 cm 96 cm 84 cm 43 cm

SW 78^{3/4"} SD 22^{3/4"} AH 26^{3/4"}
200 cm 58 cm 68 cm

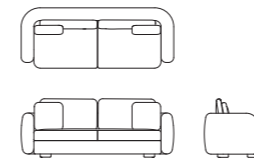

a: wood finish

DECORATIVE PILLOWS (X2) / COJINES DECORATIVOS (X2)

W 17^{3/4"} D 1^{1/2"} H 17^{3/4"}
45 cm 4 cm 45 cm



Wood finish / Acabado madera

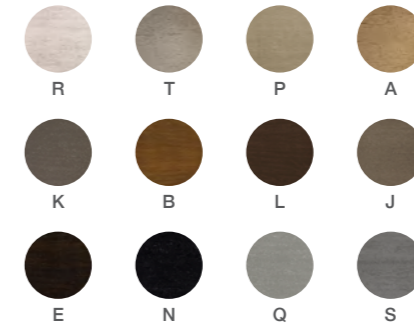

Back and decorative pillows included. / Incluye cojines de espaldar y decorativos.

LIVING ROOM | SALA

Back and decorative pillows included. / Incluye cojines de espaldar y decorativos.

LIVING ROOM | SALA

GALAPAGOS SOFA 100
sofá galápagos 100

GS12-100

w 102^{1/4"} D 46^{1/2"} H 27^{1/2"} SH 17^{3/4"}
260 cm 118 cm 70 cm 45 cm

sw 102^{1/4"} sd 25^{1/2"}
260 cm 65 cm

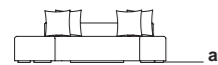
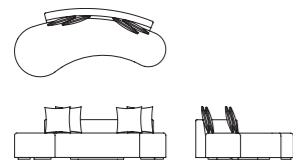

a: wood finish

BACK PILLOWS (X4) / COJINES DE ESPALDAR (X4)

w 19^{3/4"} H 19^{3/4"}
50 cm 50 cm

Wood finish / Acabado madera



Back pillows included. / Incluye cojines de espaldar.

* (H) Dimensions do not include back pillows. / * (H) Las dimensiones no incluyen los cojines de espaldar.



Referential photo. Some products, finishes or fabrics may no longer be available. /
Foto referencial. Algunos productos, acabados o telas podrían ya no estar disponibles.

GALAPAGOS SOFA 200
sofá galápagos 200

GS12-200

W 92^{1/4"} D 36^{1/4"} H 33^{3/4"} SH 17^{3/4"}
234 cm 92 cm 86 cm 45 cm

SW 78^{3/4"} SD 23^{1/4"} AH 24^{3/4"}
200 cm 59 cm 63 cm

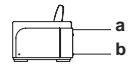
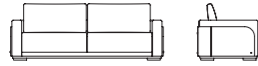
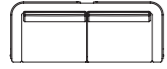

a: wood finish b: metallic button

Wood finish / Acabado madera



Metallic button / Botón metálico

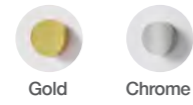

Veneer will be applied in a vertical direction. / La chapa se aplica con la veta en sentido vertical.

LIVING ROOM | SALA



Referential photo. Some products, finishes or fabrics may no longer be available. / Foto referencial. Algunos productos, acabados o telas podrían ya no estar disponibles.

LIVING ROOM | SALA

**GALAPAGOS SOFA 210
(UPHOLSTERED LEATHER
BACK)**

sofá galápagos 210
(casco tapizado cuero)

GS12-210

w 92^{1/4"} D 36^{1/4"} H 33^{3/4"} SH 17^{3/4"}
234 cm 92 cm 86 cm 45 cm

SW 78^{3/4"} SD 23^{1/4"} AH 24^{3/4"}
200 cm 59 cm 63 cm

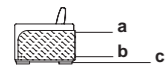
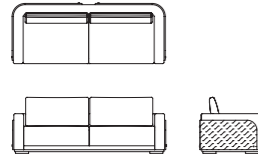

a:leather back b:metallic button c:wood finish

Wood finish / Acabado madera



Leather back / Cuero casco



Metallic button / Botón metálico

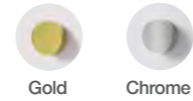

Referential photo. Some products, finishes or fabrics may no longer be available. /
Foto referencial. Algunos productos, acabados o telas podrían ya no estar disponibles.

GALAPAGOS SOFA 400
sofá galápagos 400

GS12-400

W 96" D 41 1/4" H 39 1/4" SH 19 3/4"
244 cm 105 cm 100 cm 50 cm

SW 78 3/4" SD 25 1/2" AH 23 1/2"
200 cm 65 cm 60 cm

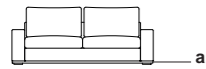
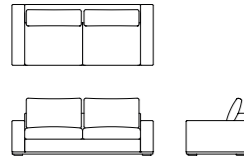

a:wood finish

GALAPAGOS SOFA 410
sofá galápagos 410

GS12-410

W 118" D 41 1/4" H 39 1/4" SH 19 3/4"
300 cm 105 cm 100 cm 50 cm

SW 100 3/4" SD 25 1/2" AH 23 1/2"
256 cm 65 cm 60 cm

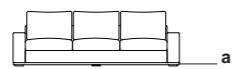
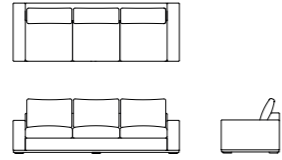

a:wood finish

Wood finish / Acabado madera



GRAFITO SOFA 100 (QUILTED ARM)
sofá grafito 100
(brazo acolchado)

GT12-100

W 94 1/2" D 39 1/4" H 33 3/4" SH 17 3/4"
240 cm 100 cm 86 cm 45 cm

SW 78 3/4" SD 25 1/2" AH 24"
200 cm 65 cm 61 cm

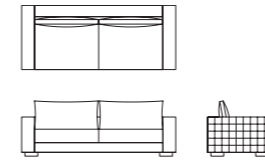

a:wood finish

GRAFITO LOVESEAT 100 (QUILTED ARM)
loveseat grafito 100
(brazo acolchado)

GT11-100

W 74 3/4" D 39 1/4" H 33 3/4" SH 17 3/4"
190 cm 100 cm 86 cm 45 cm

SW 59" SD 25 1/2" AH 24"
150 cm 65 cm 61 cm

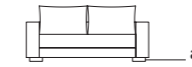
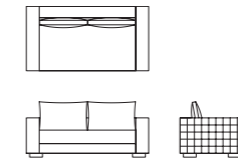



a:wood finish

Wood finish / Acabado madera

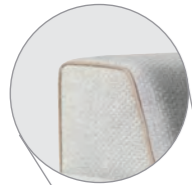

Piping detail / Detalle ribete



 **Mixed filling with feathers and down.** / Relleno combinado de plumas y plumón para garantizar mayor confort.
Feathers filling may cause wrinkles on the fabric. / El relleno de plumas puede causar arrugas en la tela.
*For detailed dimensions, please refer to the cad block. / Para dimensiones detalladas ver el bloque del mueble.
Decorative pillows not included. / Cojines decorativos no incluidos.

UPHOLSTERY OPTIONS

opciones de tapicería

GRAFITO SOFA 100 (QUILTED ARM)

sofá grafito 100 (brazo acolchado),
opciones disponibles

GT12-100

01

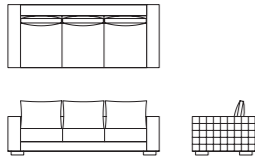

02

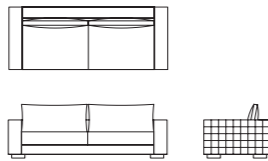

GRAFITO LOVESEAT 100 (QUILTED ARM)

loveseat grafito 100 (brazo acolchado),
opciones disponible

GT11-100

01

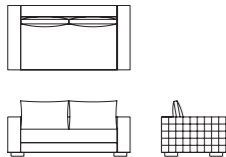

Upholstery back cushions options. / Opciones de tapicería de cojines de espaldar.



A plain / liso



B square quilted / acolchado cuadros

GRAFITO SOFA 130

(QUILTED ARM)

sofá grafito 130
(brazo acolchado)

GT12-130

w 118" D 39^{1/4}" H 33^{3/4}" SH 17^{3/4}"
300 cm 100 cm 86 cm 45 cm

SW 102^{1/4}" SD 25^{1/2}" AH 24"
260 cm 65 cm 61 cm

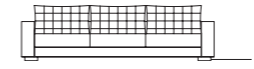
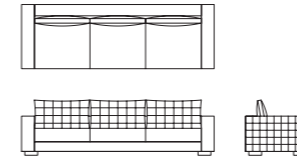

a: wood finish

Wood finish / Acabado madera

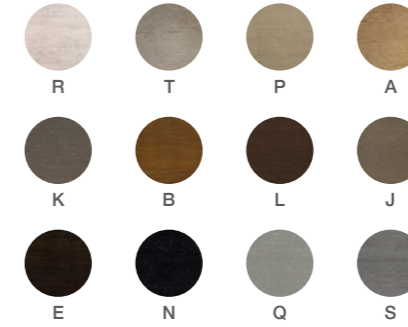

GRAFITO LOVESEAT 200
loveseat grafito 200

GT11-200

w 70^{3/4"} D 28^{3/4"} H 33^{1/2"} SH 17^{3/4"}
180 cm 73 cm 85 cm 45 cm

SW 61^{1/2"} SD 19^{3/4"} AH 25^{1/2"}
156 cm 50 cm 65 cm

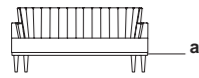
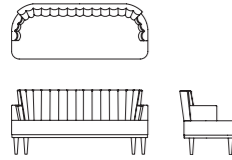

a: wood finish

Wood finish / Acabado madera



H SOFA 100
sofá h 100

HS12-100

w 84^{3/4"} D 34^{3/4"} H 28^{1/4"} SH 17^{3/4"}
215 cm 88 cm 72 cm 45 cm

SW 70^{3/4"} SD 23^{1/2"} AH 23^{1/2"}
180 cm 60 cm 60 cm

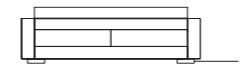
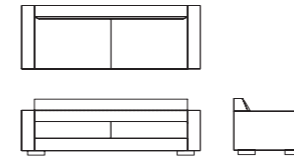

a: wood finish

Wood finish / Acabado madera

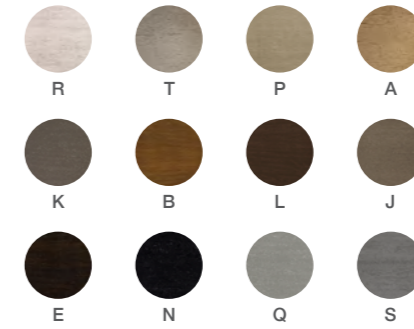

H SOFA 210
sofá h 210

HS12-210

w 86^{1/2"} D 35^{1/2"} H 30^{1/4"} SH 17^{3/4"}
220 cm 90 cm 77 cm 45 cm

sw 77^{1/4"} SD 23^{1/2"} AH 23^{1/2"}
196 cm 60 cm 60 cm

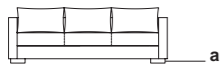
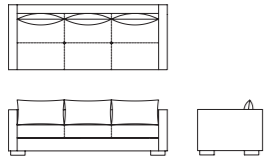

a:wood finish

H LOVESEAT 210
loveseat h 210

HS11-210

w 67" D 35^{1/2"} H 30^{1/4"} SH 17^{3/4"}
170 cm 90 cm 77cm 45 cm

sw 57^{1/2"} SD 23^{1/2"} AH 23^{1/2"}
146 cm 60 cm 60 cm

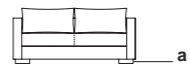
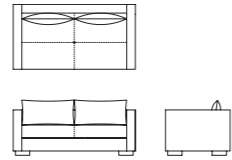

a:wood finish

Wood finish / Acabado madera



H SOFA 500
sofa h 500

HS12-500

w 86^{1/2"} D 37^{1/2"} H* 33^{3/4"} SH 17^{3/4"}
220 cm 95 cm 86 cm 45 cm

sw 69^{1/4"} SD 25^{1/2"} AH 28"
176 cm 65 cm 71 cm

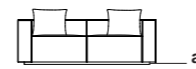
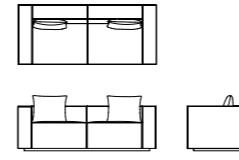

a:wood finish

BACK PILLOWS (X2) / COJINES DE ESPALDAR (X2)

w 19^{3/4"} H 19^{3/4"}
50 cm 50 cm

Inverted seam / Costura invertida



* (H) Dimensions does not include back pillows. / * (H) Las dimensiones no incluyen los cojines de espaldar.

RUMBA
CRESCENT SOFA 100
sofá rumba 100

RM12-100

w 92^{1/2}" d 38^{1/4}" h 34^{1/4}" sh 17^{3/4}"
235 cm 97 cm 87 cm 45 cm

sw 73^{1/2}" sd 25^{1/2}"
187 cm 65 cm

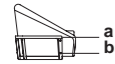
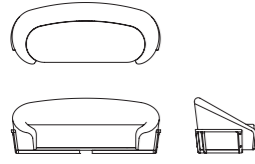

a:wood finish b:metallic button

RUMBA
CRESCENT SOFA 110
sofá rumba 110

RM12-110

w 110" d 38^{1/4}" h 34^{1/4}" sh 17^{3/4}"
280 cm 97 cm 87 cm 45 cm

sw 91^{1/4}" sd 25^{1/2}"
232 cm 65 cm

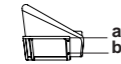
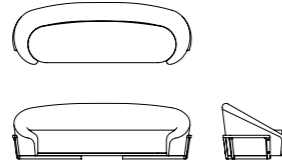

a:wood finish b:metallic button

Wood finish / Acabado madera

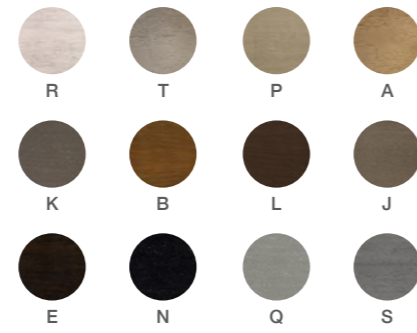

Metallic button / Botón metálico

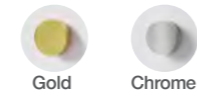

Referential photo. Some products, finishes or fabrics may no longer be available. /
Foto referencial. Algunos productos, acabados o telas podrían ya no estar disponibles.

RUMBA SOFA 200
sofá rumba 200

RM12-200

w 96" D 37" H* 35 1/2" SH 17 3/4"
244 cm 94 cm 90 cm 45 cm

sw 73 1/2" SD 25 1/2" AH 28 1/4"
187 cm 65 cm 72 cm

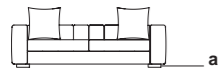
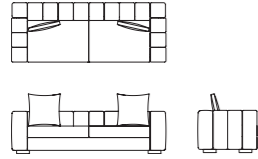

a:wood finish

BACK PILLOWS (X2) / COJINES DE ESPALDAR (X2)

w 19 3/4" D 1 1/2" H 19 3/4"
50 cm 4 cm 50 cm

RUMBA SOFA 210
sofá rumba 210

RM12-210

w 118" D 37" H* 35 1/2" SH 17 3/4"
300 cm 94 cm 90 cm 45 cm

sw 97 1/2" SD 25 1/2" AH 28 1/4"
248 cm 65 cm 72 cm

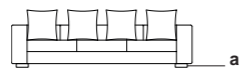
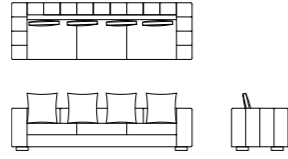

a:wood finish

Wood finish / Acabado madera



Back pillows included. / Incluye cojines de espaldar
*(H) Dimensions do not include back pillows. / *(H) Las dimensiones no incluyen los cojines de espaldar.



Referential photo. Some products, finishes or fabrics may no longer be available. / Foto referencial. Algunos productos, acabados o telas podrían ya no estar disponibles.

**TEN SOFA 110
(QUILTED ARMS)**
sofá ten 110
(brazos acolchados)

TN12-110

w 94^{1/2}" D 35^{1/2}" H 35" SH 17^{3/4}"
240 cm 90 cm 89 cm 45 cm

sw 80^{1/4}" SD 23^{1/2}" AH 24^{3/4}"
204 cm 60 cm 63 cm

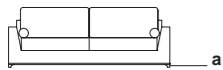
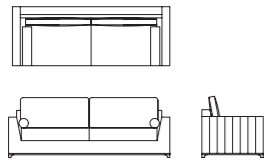

a: wood finish

**TEN LOVESEAT 110
(QUILTED ARMS)**
loveseat ten 110
(brazos acolchados)

TN11-110

w 74^{3/4}" D 35^{1/2}" H 35" SH 17^{3/4}"
190 cm 90 cm 89 cm 45 cm

sw 60^{3/4}" SD 23^{1/2}" AH 24^{3/4}"
154 cm 60 cm 63 cm

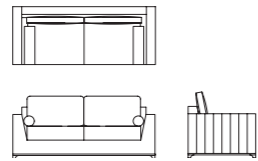

a: wood finish

Wood finish / Acabado madera



SECTIONALS
seccionales



Chocolate sectional
seccional chocolate



Caramelo sectional
seccional caramelo



Gem sectional
seccional gem



Galapagos sectional
seccional galápagos



Galapagos curved sectional
seccional galápagos curvo



H sectional
seccional h



H sectional
seccional h

Bolster pillows included. / Incluye cojines caramelo.

Slight color variations may occur while printing tear sheets due to printers pixelation and quality. Product specifications are subject to change due to product development updates. / Ligeras variaciones de color pueden ocurrir en la impresión. Las especificaciones están sujetas a cambios debido a las necesidades del producto.

Dimensions are usually approximated to the nearest quarter inch that will correspond to its metric conversion. / Las medidas generalmente se dan de acuerdo a la conversión métrica correspondiente y con una medida aproximada.

CHOCOLATE LEFT/RIGHT ARM 3 SEAT WITH WOODEN SHELVES 300
módulo chocolate 3 pue-
tos con repisas brazo
izq./der. 300

CH14-300 L/R

w 86^{1/2}" D 41^{1/4}" H 35^{1/2}" SH 17^{3/4}"
220 cm 105 cm 90 cm 45 cm

SW 78^{3/4}" SD 23^{1/2}" AH 24^{1/2}"
200 cm 60 cm 62 cm

Left | Izquierda

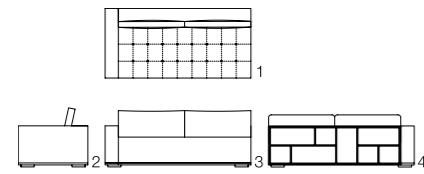

Right | Derecha

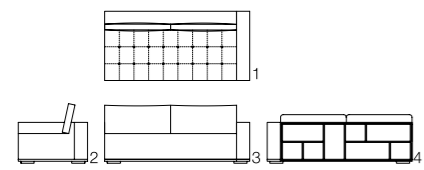

View 1: top 2: side 3: front 4: back
Vista 1: superior 2: lateral 3: frontal 4: posterior

CHOCOLATE LEFT/RIGHT ARM CHAISE WITH WOODEN SHELVES 300
chaise lounge izq./ der.
chocolate con repisa 300

CH47-300 L/R

w 41^{1/4}" D 86^{1/2}" H 35^{1/2}" SH 17^{3/4}"
105 cm 220 cm 90 cm 45 cm

SW*23^{1/2}" SD*67^{3/4}" AH 24^{1/2}"
60 cm 172 cm 62 cm

Left | Izquierda

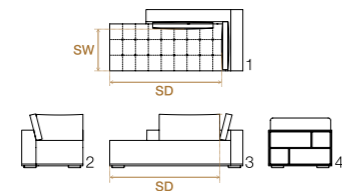

Right | Derecha

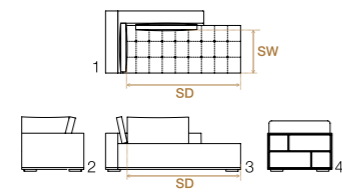

View 1: top 2: side 3: front 4: back
Vista 1: superior 2: lateral 3: frontal 4: posterior

Wood finish / Acabado madera

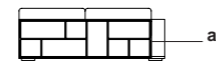

a: wood finish

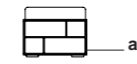

a: wood finish



CARAMELO CORNER 700
módulo esquinero
caramelo 700

CM13-700

w 39^{1/4}" D 39^{1/4}" H 34^{3/4}" SH 17^{3/4}"
100 cm 100 cm 88 cm 45 cm

SW 25^{1/2}" SD 25^{1/2}"
65 cm 65 cm

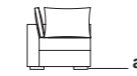
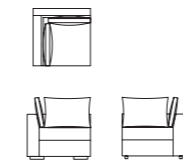

a: wood finish

CARAMELO ARMLESS 2 SEAT 700
módulo 2p caramelo 700

CM14-700

w 70^{3/4}" D 39^{1/4}" H 34^{3/4}" SH 17^{3/4}"
180 cm 100 cm 88 cm 45 cm

SW 70^{3/4}" SD 25^{1/2}"
180 cm 65 cm

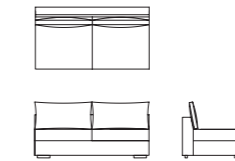

a: wood finish



Wood finish / Acabado madera

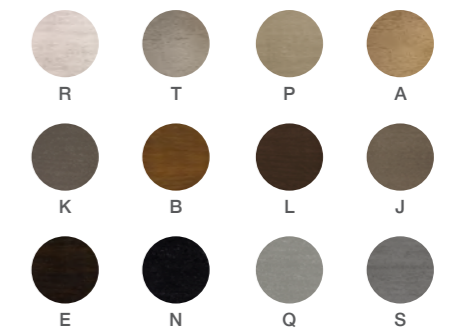

*For detailed dimensions, please refer to the cad block. / Para dimensiones detalladas ver el bloque del mueble.

CARAMELO ARMLESS 1 SEAT 710
módulo 1p caramelo 710

CM14-710

W 35^{1/2}" D 39^{1/4}" H 34^{3/4}" SH 17^{3/4}"
90 cm 100 cm 88 cm 45 cm

SW 35^{1/2}" SD 25^{1/2}"
90 cm 65 cm

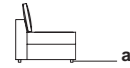
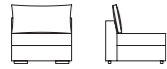

a:wood finish

CARAMELO ARMLESS CHAISE LOUNGE 700
módulo chaise lounge caramelo 700

CM47-700

W 35^{1/2}" D 63^{3/4}" H 34^{3/4}" SH 17^{3/4}"
90 cm 162 cm 88 cm 45 cm

SW* 35^{1/2}" SD* 50"
90 cm 127 cm

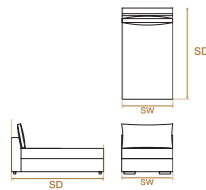

a:wood finish

CARAMELO OTTOMAN 710
otomán caramelo 710

CM16-710

W 35^{1/2}" D 35^{1/2}" H 17^{3/4}"
90 cm 90 cm 45 cm

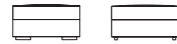

a:wood finish

Wood finish / Acabado madera



ARM OPTIONS / OPCIONES BRAZOS

CARAMELO ARM LEFT/RIGHT (PLAIN ARM)
brazo caramelo izq./der.

CM70-701

W 7^{3/4}" D 39^{1/4}" H 22"
20 cm 100 cm 56 cm



CARAMELO LEFT/RIGHT (QUILTED ARM)
brazo caramelo izq./der. (acolchado)

CM70-703

W 7^{3/4}" D 39^{1/4}" H 22"
20 cm 100 cm 56 cm

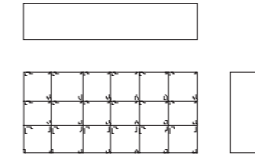

SIDE TABLE CARAMELO 750
mesa auxiliar modular caramelo 750

CM20-750

W 38^{1/2}" D 11^{3/4}" H 17^{3/4}"
98 cm 30 cm 45 cm

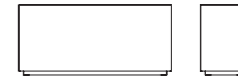

*For detailed dimensions, please refer to the cad block. / Para dimensiones detalladas ver el bloque del mueble.

BACK CUSHION OPTIONS / OPCIONES COJINES ESPALDA



A plain / liso



B square quilted / acolchado cuadros

GEM 2 LEFT/RIGHT ARM SEAT 200

módulo 2 puestos brazo izq./der. gem 200

GM14-200 L/R

W 63" D 37^{3/4}" H 33" SH 17"
160 cm 96 cm 84 cm 43 cm

SW 55" SD 22^{3/4}" AH 26^{3/4}"
140 cm 58 cm 68 cm

Right | Derecha

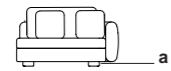
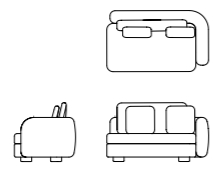

a:wood finish

Left | Izquierda

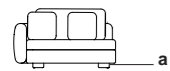
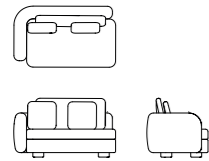

a:wood finish

DECORATIVE PILLOWS (2 PER SEAT) /
COJINES DECORATIVOS (2 POR MÓDULO)

W 17^{3/4}" D 1^{1/2}" H 17^{3/4}"
45 cm 4 cm 45 cm



Wood finish / Acabado madera



GEM 2 SEAT LEFT/RIGHT CORNER 200

módulo 2 puestos esquinero izq./der. gem 200

GM13-200 L/R

W 79^{1/2}" D 48" H 33" SH 17"
202 cm 122 cm 84 cm 43 cm

SW 79^{1/2}" SD 22^{3/4}" AH 26^{3/4}"
202 cm 58 cm 68 cm

Right | Derecha

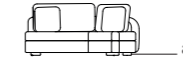
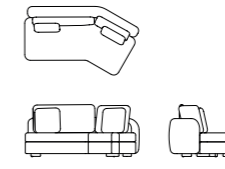

a:wood finish

Left | Izquierda

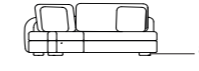
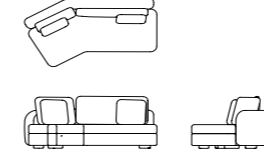

a:wood finish

DECORATIVE PILLOWS (2 PER SEAT) /
COJINES DECORATIVOS (2 POR MÓDULO)

W 17^{3/4}" D 1^{1/2}" H 17^{3/4}"
45 cm 4 cm 45 cm



Build your own! | ¡Constrúyalo usted mismo!

Here, you can find some layouts with our suggested combinations, but feel free to create a new one by yourself.
Aquí encontrará algunas combinaciones sugeridas, sin embargo le invitamos a que cree una nueva usted mismo.

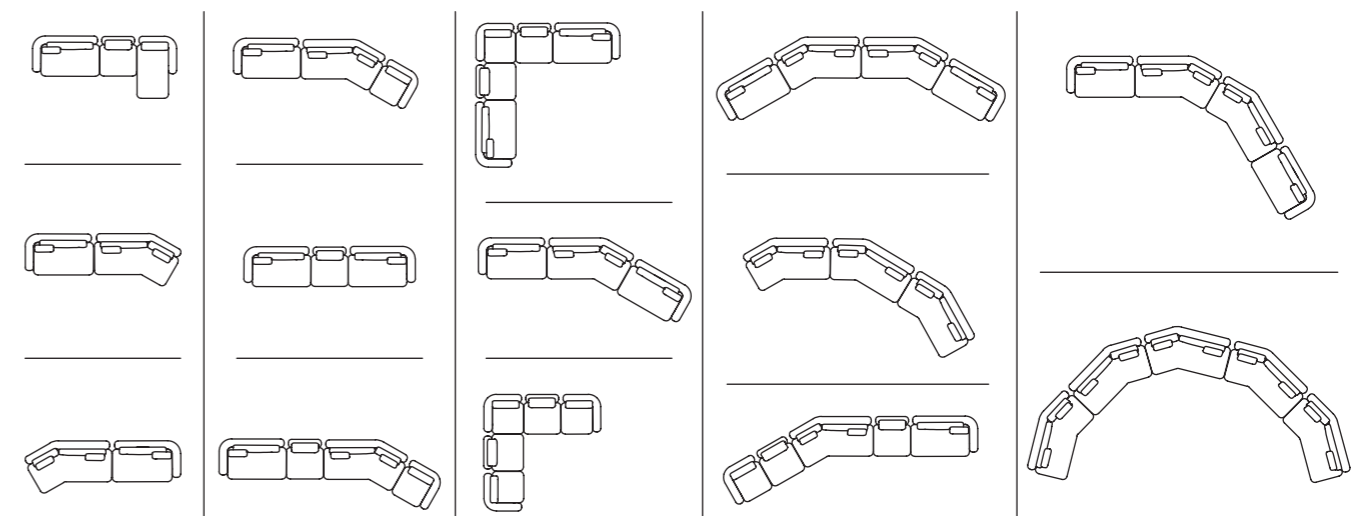

Includes two decorative pillows included per seat. / Incluye dos cojines decorativos por módulo.

Includes two decorative pillows included per seat. / Incluye dos cojines decorativos por módulo.
Nesting table not included. / No incluye mesa nesting.

GEM CORNER 210
módulo esquinero gem 210

GM13-210

w 37^{3/4}" D 37^{3/4}" H 33" SH 17"
96 cm 96 cm 84 cm 43 cm

sw 22^{3/4}" SD 30" AH 26^{3/4}"
58 cm 76 cm 68 cm

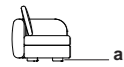
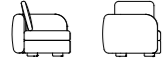

a:wood finish



GEM ARMLESS 1 SEAT 210
módulo sin brazo gem 210

GM14-210

w 35^{1/2}" D 37^{3/4}" H 33" SH 17"
90 cm 96 cm 84 cm 43 cm

sw 35^{1/2}" SD 22^{3/4}"
90 cm 58 cm



a:wood finish



Wood finish / Acabado madera



BACK PILLOWS (1 PER SEAT) /
COJINES DE ESPALDAR (1 POR MÓDULO)

w 17^{3/4}" D 1^{1/2}" H 17^{3/4}"
45 cm 4 cm 45 cm

GEM ARM CHAISE LOUNGE
L/R 200
chaise lounge gem l/r 200

GM47-200 L/R

w 37^{3/4}" D 59" H 33" SH 17"
96 cm 150 cm 84 cm 43 cm

sw 30" SD 44" AH 26^{3/4}"
76 cm 112 cm 68 cm

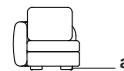
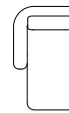

a:wood finish

One back pillow included per set. / Incluye un cojín de espalda por módulo.



Referential photo. Some products, finishes or fabrics may no longer be available. /
Foto referencial. Algunos productos, acabados o telas podrían ya no estar disponibles.

GALAPAGOS ARMLESS 2 SEAT 100
módulo 2 puestos sin brazo galápagos 100

GS14-100

W 70^{3/4"} D 41^{1/4"} H 39^{1/4"} SH 19^{3/4"}
180 cm 105 cm 100 cm 50 cm

SW 70^{3/4"} SD 25^{1/2"}
180 cm 65 cm

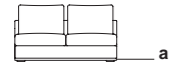
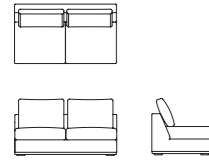

a:wood finish



GALAPAGOS HEXAGONAL ARMLESS SEAT 100
módulo hexagonal galápagos 100

GS13-100

W 94^{1/2"} D 53^{1/4"} H 39^{1/4"} SH 19^{3/4"}
240 cm 135 cm 100 cm 50 cm

SW 76^{3/4"} SD 37^{1/2"}
195 cm 95 cm

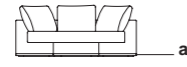
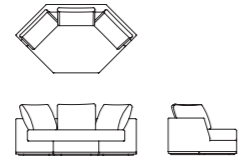

a:wood finish



Wood finish / Acabado madera



Piping detail / Detalle ribete

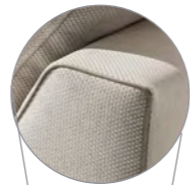

 **Mixed filling with feathers and down.** / Relleno combinado de plumas y plumón para garantizar mayor confort.
Feathers filling may cause wrinkles on the fabric. / El relleno de plumas puede causar arrugas en la tela.
*For detailed dimensions, please refer to the cad block. / Para dimensiones detalladas ver el bloque del mueble.
Decorative pillows not included / Cojines decorativos no incluidos.

GALAPAGOS ARMLESS 1 SEAT 110
módulo 1p sin brazo galápagos 110

GS14-110

W 35^{1/2"} D 41^{1/4"} H 39^{1/4"} SH 19^{3/4"}
90 cm 105 cm 100 cm 50 cm

SW 35^{1/2"} SD 25^{1/2"}
90 cm 65 cm

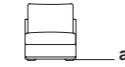
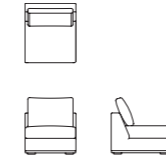

a:wood finish



GALAPAGOS ARMLESS CHAISE LOUNGE 110
chaise lounge sin brazo galápagos 110

GS47-110

W 41^{1/4"} D 63" H 39^{1/4"} SH 19^{3/4"}
105 cm 160 cm 100 cm 50 cm

SW* 41^{1/4"} SD* 47^{1/4"}
105 cm 120 cm

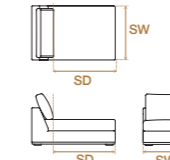

a:wood finish



Wood finish / Acabado madera



GALAPAGOS ARM L/R 700
brazo galápagos der./izq. 700

GS70-700

W 8^{3/4"} D 41^{1/4"} H 23^{1/2"}
22 cm 105 cm 60 cm

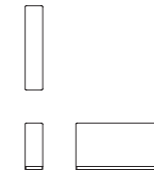

a:wood finish



 **Mixed filling with feathers and down.** / Relleno combinado de plumas y plumón para garantizar mayor confort.
Feathers filling may cause wrinkles on the fabric. / El relleno de plumas puede causar arrugas en la tela.
*For detailed dimensions, please refer to the cad block. / Para dimensiones detalladas ver el bloque del mueble.
Decorative pillows not included / Cojines decorativos no incluidos.

GALAPAGOS OTTOMAN 200
otomán galápagos 200

GS16-200

W 35^{1/2"} D 41^{1/4"} H 19^{3/4"}
90 cm 105 cm 50 cm



a:wood finish



GALAPAGOS CORNER 200
módulo esquinero galápagos 200

GS13-200

W 41^{1/4"} D 41^{1/4"} H 39^{1/4"} SH 19^{3/4"}
105 cm 105 cm 100 cm 50 cm

sw 25^{1/2"} sd 25^{1/2"}
65 cm 65 cm



a:wood finish



Wood finish / Acabado madera



Build your own! | ¡Constrúyalo usted mismo!

Here, you can find some layouts with our suggested combinations, but feel free to create a new one by yourself.
Aquí encontrará algunas combinaciones sugeridas, sin embargo le invitamos a que cree una nueva usted mismo.

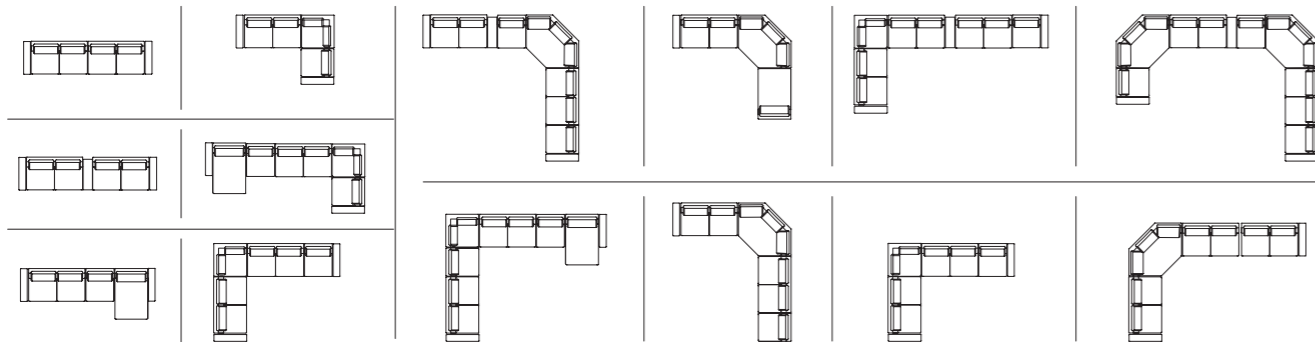

Mixed filling with feathers and down. / Relleno combinado de plumas y plumón para garantizar mayor confort.
Feathers filling may cause wrinkles on the fabric. / El relleno de plumas puede causar arrugas en la tela.
*For detailed dimensions, please refer to the cad block. / Para dimensiones detalladas ver el bloque del mueble.
Decorative pillows not included / Cojines decorativos no incluidos.



GALAPAGOS CURVED LEFT / RIGHT ARMLESS SOFA 300
módulo curvo der./izq. sin brazo galápagos 300

GS14-300 L/R

W 94^{1/2"} D 41^{1/4"} H* 35^{1/2"} SH 17^{3/4"}
240 cm 105 cm 90 cm 45 cm

SW 94^{1/2"} SD* 25^{1/2"}
240 cm 65 cm

BACK PILLOW (X3) / COJÍN ESPALDAR (X3)

W 19^{3/4"} H 19^{3/4"}
50 cm 50 cm

Left | Izquierda

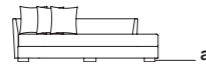
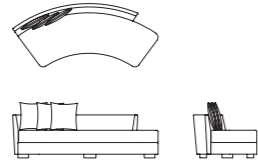

a:wood finish



Right | Derecha

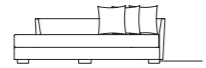
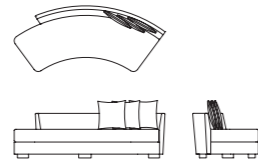

a:wood finish



Back pillows included. / Incluye cojines de espalda.

*(H) (SD) Dimensions do not include back pillows. / (H) (SD) No incluye las dimensiones de los cojines del espaldar.

Wood finish / Acabado madera



GALAPAGOS 1 SEAT 310
módulo 1p galápagos 310

GS14-310

W 51^{1/4"} D 32" H 27^{1/2"} SH 17^{3/4"}
130 cm 81 cm 70 cm 45 cm

SD 25^{1/2"}
65 cm

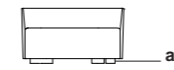
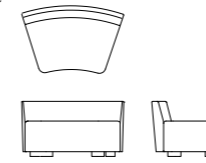

a:wood finish



GALAPAGOS OTTOMAN 300
otomán galápagos 300

GS16-300

W 45^{3/4"} D 28" H 17^{3/4"}
116 cm 71 cm 45 cm

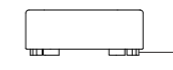
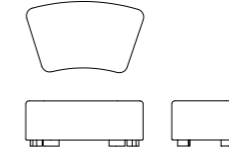

a:wood finish



Wood finish / Acabado madera



Build your own! | ¡Constrúyalo usted mismo!

Here, you can find some layouts with our suggested combinations, but feel free to create a new one by yourself. Aquí encontrará algunas combinaciones sugeridas, sin embargo le invitamos a que cree una nueva usted mismo.

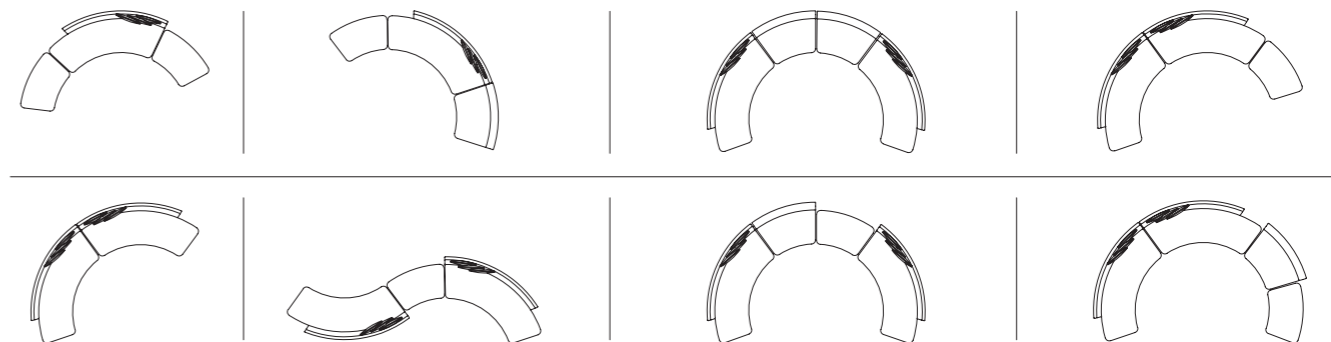



H LEFT/RIGHT ARM 2 SEAT + CHAISE LOUNGE LEFT/RIGHT 200

módulo 2p brazo izq./der. + chaise lounge brazo izq./der. h 200

HS14-200 L/R

h left/right arm 2 seat 200 / módulo 2p brazo izq./der. h 200

w 66^{1/4"} D 34^{3/4"} H 28^{1/4"} SH 17^{3/4"}
168 cm 88 cm 72 cm 45 cm

sw 59" SD 23^{1/2"} AH 23^{1/4"}
150 cm 60 cm 59 cm

Left | Izquierda

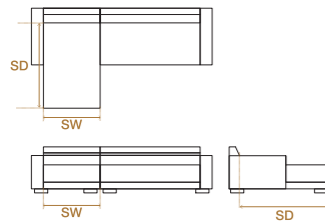

a:wood finish

h left/right arm chaise lounge 200 / chaise lounge izq./der. h 200

w 40^{1/2"} D 59" H 28^{1/4"} SH 17^{3/4"}
103 cm 150 cm 72 cm 45 cm

sw 33^{1/2"} SD 49^{1/2"} AH 23^{1/4"}
85 cm 126 cm 59 cm

Right | Derecha

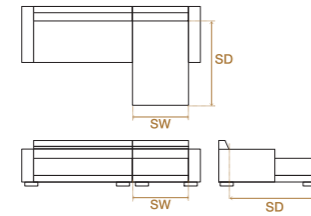

a:wood finish



Wood finish / Acabado madera



H LEFT/RIGHT 2 SEAT + CHAISE LOUNGE LEFT/RIGHT ARM 210

módulo 2p brazo izq./der. + chaise lounge brazo izq./der. h 210

HS14-210 L/R

h left/right arm 2 seat 210 / módulo 2p brazo izq./der. h 210

w 65" D 35^{1/2"} H 30^{1/4"} SH 17^{3/4"}
165 cm 90 cm 77 cm 45 cm

sw 60^{1/4"} SD 23^{1/2"} AH 24^{3/4"}
153 cm 60 cm 63 cm

Left | Izquierda

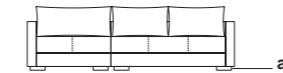
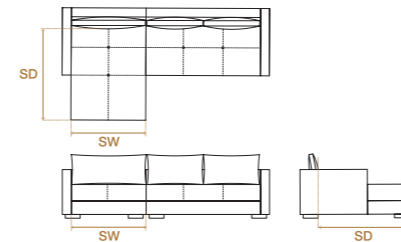

a:wood finish

h left/right arm chaise lounge 210 / chaise lounge brazo izq./der. h 210

w 44" D 59" H 30^{1/4"} SH 17^{3/4"}
112 cm 150 cm 77 cm 45 cm

sw 39^{1/4"} SD 51^{1/4"} AH 24^{3/4"}
100 cm 130 cm 63 cm

Right | Derecha

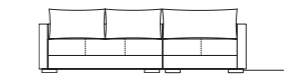
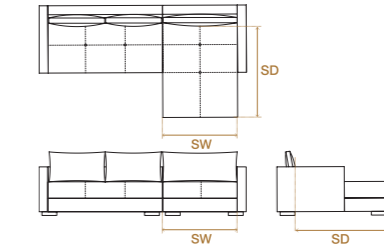

a:wood finish



Wood finish / Acabado madera



*For detailed dimensions, please refer to the cad block. / Para dimensiones detalladas ver el bloque del mueble.

*For detailed dimensions, please refer to the cad block. / Para dimensiones detalladas ver el bloque del mueble.

UPHOLSTERED CHAIRS

poltronas



EDUARDO ROCKING CHAIR 130
meecedora eduardo 130



BOLERO UPHOLSTERED CHAIR 220
poltrona bolero 220



BOLERO UPHOLSTERED CHAIR 300
poltrona bolero 300



H UPHOLSTERED CHAIR 100
poltrona h 100



H UPHOLSTERED CHAIR 300
poltrona h 300



RUMBA UPHOLSTERED CHAIR 101
poltrona rumba 101



CHOCOLATE ICONIC UPHOLSTERED CHAIR 900
poltrona icónica chocolate 900



CARAMELO UPHOLSTERED CHAIR 140
poltrona caramelo 140



GEM UPHOLSTERED CHAIR 100
poltrona gem 100



RUMBA UPHOLSTERED CHAIR 111
poltrona rumba 111



RUMBA UPHOLSTERED CHAIR 200
poltrona rumba 200



RUMBA UPHOLSTERED CHAIR 201
poltrona rumba 201



GEM UPHOLSTERED CHAIR 111
poltrona gem 111



GEM UPHOLSTERED CHAIR 201
poltrona gem 201



GALAPAGOS UPHOLSTERED 101
poltrona galápagos 101



RUMBA UPHOLSTERED CHAIR 202
poltrona rumba 202



RUMBA PETITE UPHOLSTERED CHAIR 301
poltrona rumba petite 301



RUMBA HANGING CHAIR 900
silla colgante rumba 900



GALAPAGOS UPHOLSTERED 200
poltrona galápagos 200



GALAPAGOS UPHOLSTERED CHAIR 400
poltrona galápagos 400



GALAPAGOS ICONIC UPHOLSTERED CHAIR 900
poltrona icónica galápagos 900



TEN UPHOLSTERED CHAIR 200
poltrona ten 200



TEN UPHOLSTERED CHAIR 210
poltrona ten 210



TEN UPHOLSTERED PETITE CHAIR 300
poltrona ten petite 300



TEN UPHOLSTERED CHAIR 400
poltrona ten 400

Slight color variations may occur while printing tear sheets due to printers pixelation and quality. Product specifications are subject to change due to product development updates. / Ligeras variaciones de color pueden ocurrir en la impresión. Las especificaciones están sujetas a cambios debido a las necesidades del producto.

Dimensions are usually approximated to the nearest quarter inch that will correspond to its metric conversion. / Las medidas generalmente se dan de acuerdo a la conversión métrica correspondiente y con una medida aproximada.

UPHOLSTERED CHAIRS

poltronas



H UPHOLSTERED CHAIR 100
poltrona h 100



H UPHOLSTERED CHAIR 300
poltrona h 300



RUMBA UPHOLSTERED CHAIR 101
poltrona rumba 101



CHOCOLATE ICONIC UPHOLSTERED CHAIR 900
poltrona icónica chocolate 900



CARAMELO UPHOLSTERED CHAIR 140
poltrona caramelo 140



GEM UPHOLSTERED CHAIR 100
poltrona gem 100



RUMBA UPHOLSTERED CHAIR 111
poltrona rumba 111



RUMBA UPHOLSTERED CHAIR 200
poltrona rumba 200



RUMBA UPHOLSTERED CHAIR 201
poltrona rumba 201



GEM UPHOLSTERED CHAIR 111
poltrona gem 111



GEM UPHOLSTERED CHAIR 201
poltrona gem 201



GALAPAGOS UPHOLSTERED 101
poltrona galápagos 101



RUMBA UPHOLSTERED CHAIR 202
poltrona rumba 202



RUMBA PETITE UPHOLSTERED CHAIR 301
poltrona rumba petite 301



RUMBA HANGING CHAIR 900
silla colgante rumba 900



GALAPAGOS UPHOLSTERED 200
poltrona galápagos 200



GALAPAGOS UPHOLSTERED CHAIR 400
poltrona galápagos 400



GALAPAGOS ICONIC UPHOLSTERED CHAIR 900
poltrona icónica galápagos 900



TEN UPHOLSTERED CHAIR 200
poltrona ten 200



TEN UPHOLSTERED CHAIR 210
poltrona ten 210



TEN UPHOLSTERED PETITE CHAIR 300
poltrona ten petite 300



TEN UPHOLSTERED CHAIR 400
poltrona ten 400

Slight color variations may occur while printing tear sheets due to printers pixelation and quality. Product specifications are subject to change due to product development updates. / Ligeras variaciones de color pueden ocurrir en la impresión. Las especificaciones están sujetas a cambios debido a las necesidades del producto.

Dimensions are usually approximated to the nearest quarter inch that will correspond to its metric conversion. / Las medidas generalmente se dan de acuerdo a la conversión métrica correspondiente y con una medida aproximada.

EDUARDO ROCKING CHAIR 130
mecedora eduardo 130

BR10-130

w 27^{1/2"} D 39^{1/4"} H 31^{1/2"} SH 17^{3/4"}
70 cm 100 cm 80 cm 45 cm

SW 21^{3/4"} SD 21^{3/4"} AH 22^{3/4"}
55 cm 55 cm 58 cm

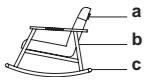

a:decorative hardware b:base finish c:metal finish

Base finish / Acabado base

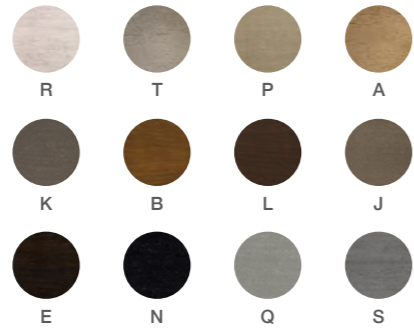

Metal finish / Acabado metal



Decorative hardware / Herraje decorativo

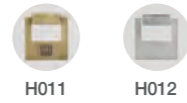

BOLERO UPHOLSTERED CHAIR 220
poltrona bolero 220

BR10-220

w 28^{3/4"} D 34^{3/4"} H 32" SH 17^{3/4"}
73 cm 88 cm 81 cm 45 cm

SW 26" SD 23^{1/4"} AH 22"
66 cm 59 cm 56 cm

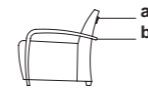
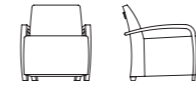

a:decorative hardware b:wood finish

Wood finish / Acabado madera

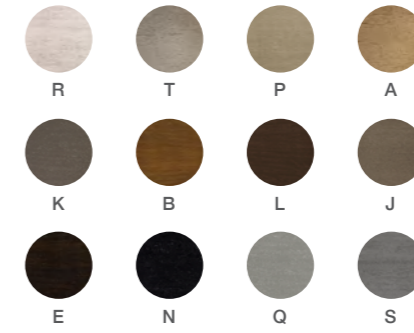

Decorative hardware / Herraje decorativo

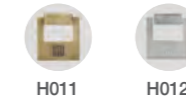

BOLERO UPHOLSTERED CHAIR 300

poltrona bolero 300

BR10-300

w 27^{1/2}" D 31^{1/2}" H 30" SH 17^{3/4}"
70 cm 80 cm 76 cm 45 cm

sw 22" SD 27^{1/4}"
56 cm 69 cm

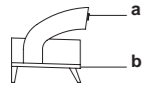
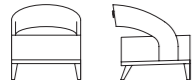

a:decorative hardware b:wood finish

Wood finish / Acabado madera

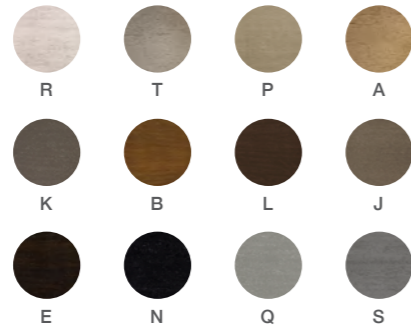

Decorative hardware / Herraje decorativo

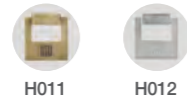

CHOCOLATE ICONIC UPHOLSTERED CHAIR 900

poltrona icónica chocolate 900

CH10-900

w 44" D 31^{1/2}" H 67" SH 19^{3/4}"
112 cm 80 cm 170 cm 50 cm

sw 38^{1/2}" SD 26^{3/4}"
98 cm 68 cm

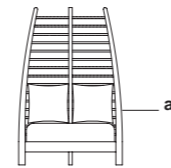
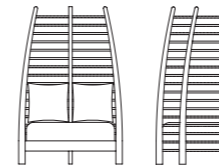
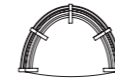

a:wood finish

BACK PILLOWS (X2) / COJINES DE ESPALDAR (X2)

w 19^{3/4}" D 1^{1/2}" H 19^{3/4}"
50 cm 4 cm 50 cm

Wood finish / Acabado madera

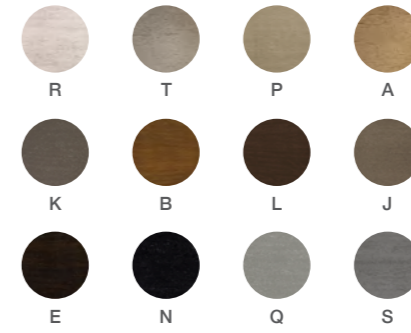

Back pillows included. / Incluye cojines de espaldar.

CARAMELO UPHOLSTERED CHAIR 140

poltrona caramelo 140

CM10-140

W 29^{1/4"} D 28^{1/4"} H 33" SH 17^{3/4"}
74 cm 72 cm 84 cm 45 cm

SW 29^{1/4"} SD 26^{1/2"}
74 cm 67 cm

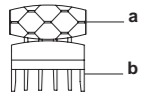
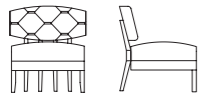

a:decorative plate b:wood finish

Wood finish / Acabado madera



Decorative plate / Placa decorativa

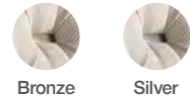

GEM UPHOLSTERED CHAIR 100

poltrona gem 100

GM10-100

W 28^{3/4"} D 26^{1/2"} H 32^{3/4"} SH 17^{3/4"}
73 cm 67 cm 83 cm 45 cm

SW 21^{1/4"} SD 20" AH 25^{1/4"}
54 cm 51 cm 64 cm



a:wood finish

Wood finish / Acabado madera

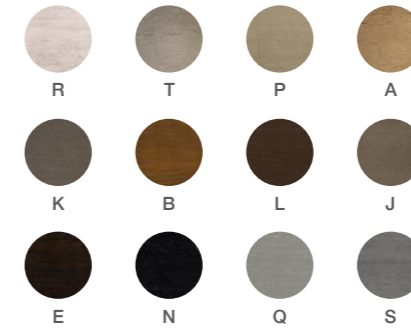

Piping detail / Detalle ribete

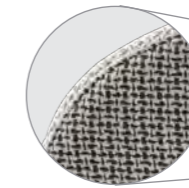

Piping can be customized. / El ribete es personalizable.



Referential photo. Some products, finishes or fabrics may no longer be available. /
Foto referencial. Algunos productos, acabados o telas podrían ya no estar disponibles.

GEM UPHOLSTERED CHAIR 111 (SWIVEL)
 poltrona gem 111
 (mecanismo giratorio)

GM10-111

w 36^{1/4"} D 30^{3/4"} H 32^{3/4"} SH 17^{3/4"}
 92 cm 78 cm 83 cm 45 cm

sw 25^{1/4"} SD 22" AH 25^{1/2"}
 64 cm 56 cm 65 cm

Wood finish / Acabado madera

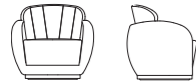
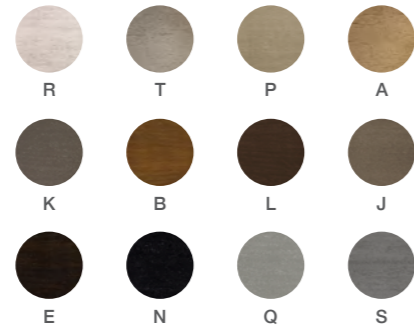

a: wood finish



GEM UPHOLSTERED CHAIR 201 (SWIVEL)
 poltrona gem 201
 (mecanismo giratorio)

GM10-201

w 36^{1/4"} D 33" H 34^{3/4"} SH 17^{3/4"}
 92 cm 84 cm 88 cm 45 cm

sw 28" SD 20" AH 26^{3/4"}
 71 cm 51 cm 68 cm

Wood finish / Acabado madera

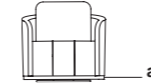
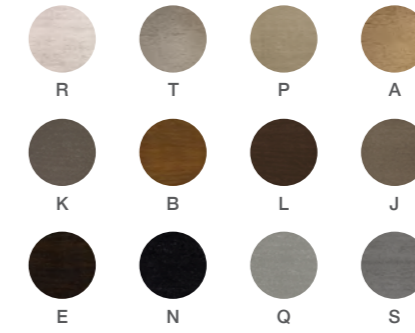

a: wood finish

BACK PILLOW (X1) / COJÍN DE ESPALDAR (X1)

w 19^{3/4"} D 1^{1/2"} H 23^{1/2"}
 50 cm 4 cm 60 cm



Back pillow included. / Incluye cojín de espaldar.



Referential photo. Some products, finishes or fabrics may no longer be available. /
Foto referencial. Algunos productos, acabados o telas podrían ya no estar disponibles.

LIVING ROOM | SALA

 ADRIANA HOYOS

**GALAPAGOS
UPHOLSTERED CHAIR 101
(SWIVEL)**
poltrona galápagos 101
(mecanismo giratorio)

GS10-101

w 23^{1/2}" D 29^{1/4}" H 30^{3/4}" SH 17^{3/4}"
60 cm 74 cm 78 cm 45 cm

sw 23^{1/2}" sd 21^{3/4}"
60 cm 55 cm

Wood finish / Acabado madera



Piping detail / Detalle ribete

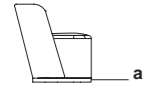
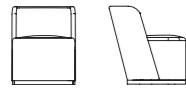

a: wood finish



Piping can be customized. / El ribete es personalizable.

LIVING ROOM | SALA



Referential photo. Some products, finishes or fabrics may no longer be available. /
Foto referencial. Algunos productos, acabados o telas podrían ya no estar disponibles.

LIVING ROOM | SALA

**GALAPAGOS
UPHOLSTERED CHAIR 200**
poltrona galápagos 200

GS10-200

w 27^{1/2}" D 27^{1/2}" H 29^{1/2}" SH 16^{1/2}"
70 cm 70 cm 75 cm 42 cm

sw 23^{1/2}" sd 21^{3/4}" ah 25^{1/2}"
60 cm 55 cm 65 cm

Wood finish / Acabado madera

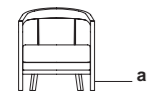
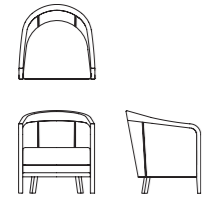

a: wood finish

Piping detail / Detalle ribete

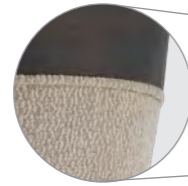

Piping can be customized. / El ribete es personalizable.

LIVING ROOM | SALA



Referential photo. Some products, finishes or fabrics may no longer be available. /
Foto referencial. Algunos productos, acabados o telas podrían ya no estar disponibles.

LIVING ROOM | SALA

GALAPAGOS
UPHOLSTERED CHAIR 400
 poltrona galápagos 400

GS10-400

W 28" D 33 1/2" H 32 3/4" SH 17 3/4"
 71 cm 85 cm 83 cm 45 cm

SW 22 3/4" SD 21 3/4" AH 24 3/4"
 58 cm 55 cm 63 cm



a: wood finish

BACK PILLOW (X1) / COJÍN DE ESPALDAR (X1)

W 19 3/4" D 1 1/2" H 19 3/4"
 50 cm 4 cm 50 cm

Wood finish / Acabado madera

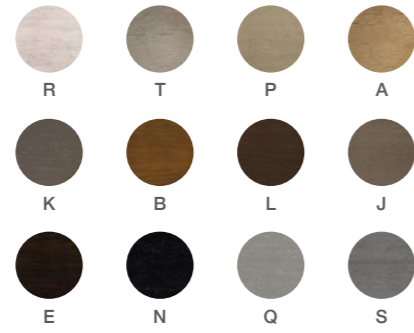

Piping detail / Detalle ribete



Piping can be customized. / El ribete es personalizable.
 Back pillow included. / Incluye cojín de espalda.

LIVING ROOM | SALA



Referential photo. Some products, finishes or fabrics may no longer be available. /
 Foto referencial. Algunos productos, acabados o telas podrían ya no estar disponibles.

LIVING ROOM | SALA

**GALAPAGOS ICONIC
UPHOLSTERED CHAIR
900 (SWIVEL)**
poltrona icónica
galápagos 900
(mecanismo giratorio)

GS10-900

w 43^{1/4"} D 31" H 55^{1/2"} SH 17^{3/4"}
110 cm 79 cm 141 cm 45 cm

SW 32^{3/4"} SD 22"
83 cm 56 cm

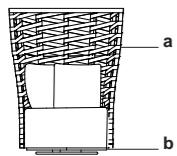
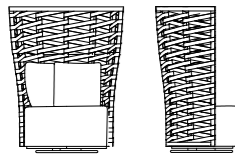

a:rope b:wood finish

BACK PILLOWS (X1) / COJINES DE ESPALDAR (X1)

w 17^{3/4"} D 2^{1/4"} H 17^{3/4"}
45 cm 6 cm 45 cm

BACK PILLOWS (X1) / COJINES DE ESPALDAR (X1)

w 19^{3/4"} H 19^{3/4"}
50 cm 50 cm

Wood finish / Acabado madera



Rope / Reata

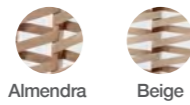

Piping detail / Detalle ribete



Piping can be customized. / El ribete es personalizable.
Back pillows included. / Incluye cojines de espaldar.

HAND MADE Special Lead Time: please confirm this product lead time before placing any order. /
Tiempo de entrega especial: por favor verificar el plazo de entrega del producto antes de poner la orden.

**H UPHOLSTERED
CHAIR 100**
poltrona h 100

HS10-100

w 26" D 29^{1/2"} H 28^{3/4"} SH 17^{3/4"}
66 cm 75 cm 73 cm 45 cm

SW 26" SD 20^{3/4"}
66 cm 53 cm

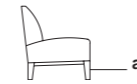

a:wood finish

Wood finish / Acabado madera

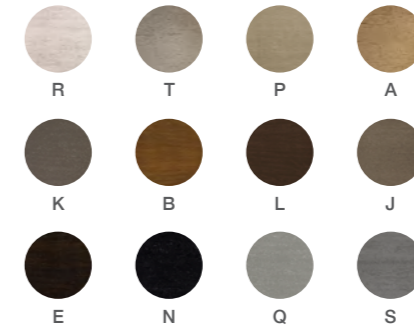

H UPHOLSTERED CHAIR 300
poltrona h 300

HS10-300

w 27^{1/2"} d 33^{1/2"} h 31^{1/2"} sh 17^{3/4"}
70 cm 85 cm 80 cm 45 cm

sw 27^{1/2"} sd 22"
70 cm 56 cm



a: wood finish

Wood finish / Acabado madera

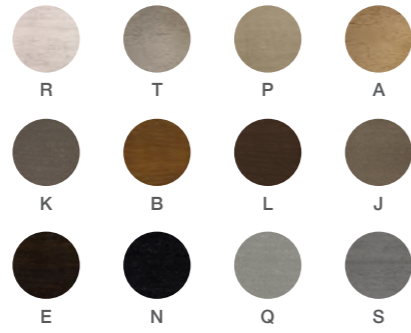

RUMBA UPHOLSTERED CHAIR 101 (SWIVEL)
poltrona rumba 101 (mecanismo giratorio)

RM10-101

w 31^{1/2"} d 28^{3/4"} h 31^{1/2"} sh 17^{3/4"}
80 cm 73 cm 80 cm 45 cm

sw 27^{1/2"} sd 21^{3/4"}
70 cm 55 cm

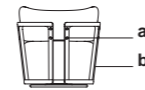

a: metallic button b: wood finish

Wood finish / Acabado madera

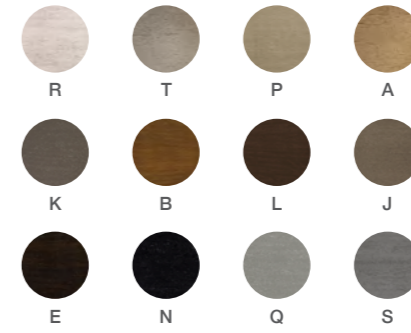

Metallic button / Botón metálico

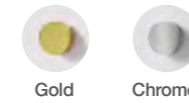



Referential photo. Some products, finishes or fabrics may no longer be available. /
Foto referencial. Algunos productos, acabados o telas podrían ya no estar disponibles.

**RUMBA UPHOLSTERED
CHAIR 111 (SWIVEL)**
poltrona rumba 111
(mecanismo giratorio)

RM10-111

w 31^{1/2}" D 28^{3/4}" H* 31^{1/2}" SH 17^{3/4}"
80 cm 73 cm 80 cm 45 cm

sw 27^{1/2}" sd* 23^{1/2}"
70 cm 60 cm

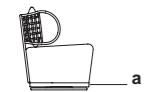
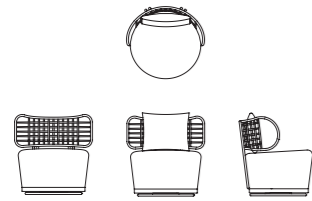

a: wood finish

BACK PILLOW (X1) / COJÍN DE ESPALDAR (X1)

w 19^{3/4}" H 19^{3/4}"
50 cm 50 cm

Wood finish / Acabado madera



Hand-woven back / Espaldar tejido a mano



Back pillow included. / Incluye cojines de espaldar.

* (H) (SD) dimensions do not include back pillow. / (H) (SD) no incluye cojín de espaldar.



Special Lead Time: please confirm this product lead time before placing any order. /
Tiempo de entrega especial: por favor confirmar el plazo de entrega del producto antes de poner la orden.



Referential photo. Some products, finishes or fabrics may no longer be available. /
Foto referencial. Algunos productos, acabados o telas podrían ya no estar disponibles.

RUMBA
UPHOLSTERED CHAIR 200
poltrona rumba 200

RM10-200

w 36^{1/4"} d 35^{1/2"} h 32" sh 17^{3/4"}
92 cm 90 cm 81 cm 45 cm

sw 25^{1/2"} sd 21^{3/4"}
65 cm 55 cm

Metal finish / Acabado metal

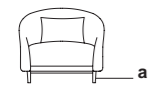
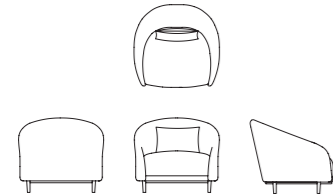

a: metal finish

LUMBAR PILLOW (X1) / COJÍN LUMBAR (X1)

w 19" h 13"
48 cm 33 cm



Lumbar pillow included. / Incluye cojín lumbar.

LIVING ROOM | SALA



Referential photo. Some products, finishes or fabrics may no longer be available. / Foto referencial. Algunos productos, acabados o telas podrían ya no estar disponibles.

LIVING ROOM | SALA

RUMBA UPHOLSTERED CHAIR 201 (SWIVEL)
 poltrona rumba 201
 (mecanismo giratorio)

RM10-201

w 36^{1/4"} D 35^{1/2"} H 32"
 92 cm 90 cm 81 cm SH 17^{3/4"}
 45 cm

SW 25^{1/2"} SD 21^{3/4"}
 65 cm 55 cm

Wood finish / Acabado madera

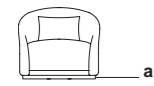
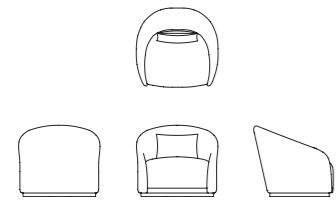

a: wood finish

LUMBAR PILLOW (X1) / COJÍN LUMBAR (X1)

w 19" H 13"
 48 cm 33 cm



Lumbar pillow included. / Incluye cojín lumbar.

LIVING ROOM | SALA



Referential photo. Some products, finishes or fabrics may no longer be available. /
 Foto referencial. Algunos productos, acabados o telas podrían ya no estar disponibles.

LIVING ROOM | SALA

RUMBA UPHOLSTERED CHAIR 202

poltrona rumba 202

RM10-202

w 36^{1/4"} D 35^{1/2"} H 32" SH 17^{3/4"}
92 cm 90 cm 81 cm 45 cm

sw 25^{1/2"} SD 21^{3/4"}
65 cm 55 cm

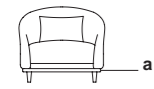
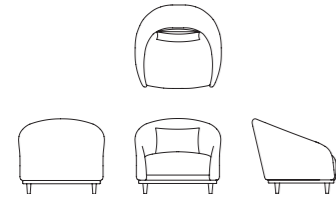

a: wood finish

LUMBAR PILLOW (X1) / COJÍN LUMBAR (X1)

w 19" H 13"
48 cm 33 cm

Wood finish / Acabado madera



Lumbar pillow included. / Incluye cojín lumbar.

RUMBA PETITE UPHOLSTERED CHAIR 301 (SWIVEL)
poltrona rumba petite 301 (mecanismo giratorio)

RM10-301

w 32" D 30^{1/4"} H 28^{3/4"} SH 17^{3/4"}
81 cm 77 cm 73 cm 45 cm

sw 22^{3/4"} SD 21^{3/4"}
58 cm 55 cm

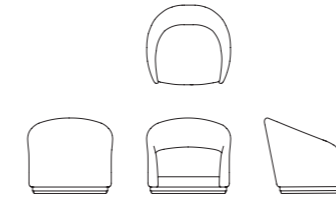

a: wood finish

Wood finish / Acabado madera

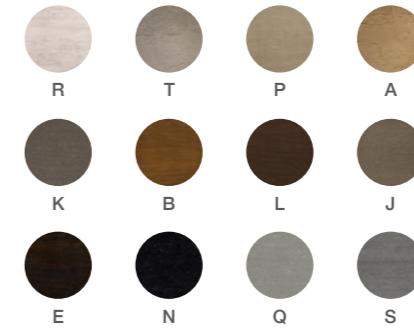



Referential photo. Some products, finishes or fabrics may no longer be available. /
Foto referencial. Algunos productos, acabados o telas podrían ya no estar disponibles.

RUMBA
HANGING CHAIR 900
 silla colgante rumba 900

RM10-900

w 39^{1/4"} d 33" H 45^{1/4"} SH 19^{3/4"}
 100 cm 84 cm 115 cm 50 cm

sw 25^{1/2"} sd 20"
 65 cm 51 cm



LUMBAR PILLOW (X1) / COJÍN LUMBAR (X1)

w 17^{3/4"} H 11^{3/4"}
 45 cm 30 cm

Hand-woven back / Espaldar tejido a mano



SPECS / ESPECIFICACIONES

maximum sitting weight capacity:
 300 lbs. / capacidad máxima de peso en
 el asiento: 300 lbs.

residential - indoor use only / residencial -
 sólo para uso interior

includes hanging rope and snap hook
 with coupling plate / incluye cuerda para
 colgar y gancho con placa de sujeción



Lumbar & seat cushion included /
 Incluye cojín lumbar y asiento



Special Lead Time: please confirm this product lead time before placing any order. /
 Tiempo de entrega especial: por favor confirmar el plazo de entrega del producto antes de poner la orden.

For proper installation please refer to the Hanging Chair Owner's Manual. | For Product Limited Warranty Disclaimer contact your Sales Rep / Para una
 correcta instalación por favor referirse al Manual de Instalación. | Para saber sobre la garantía del producto consulte con su asesor de ventas.

Referential photo. Some products, finishes or fabrics may no longer be available. /
 Foto referencial. Algunos productos, acabados o telas podrían ya no estar disponibles.

TEN UPHOLSTERED CHAIR 200
poltrona ten 200

TN10-200

w 30^{1/4"} D 32^{1/4"} H 39^{1/4"} SH 17^{3/4"}
77 cm 82 cm 100 cm 45 cm

sw 26^{1/2"} SD 21^{3/4"} AH 23^{1/2"}
67 cm 55 cm 60 cm

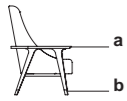
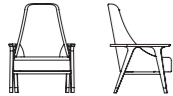

a:base finish **b**:metal finish

Base finish / Acabado base

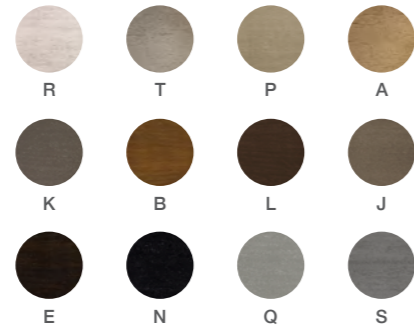

Metal finish / Acabado metálico



TEN UPHOLSTERED CHAIR 210
poltrona ten 210

TN10-210

w 30^{1/4"} D 29^{1/2"} H 34^{3/4"} SH 17^{3/4"}
77 cm 75 cm 88 cm 45 cm

sw 26^{1/2"} SD 21^{3/4"} AH 23^{1/2"}
67 cm 55 cm 60 cm

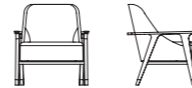

a:base finish **b**:metal finish

Base finish / Acabado base

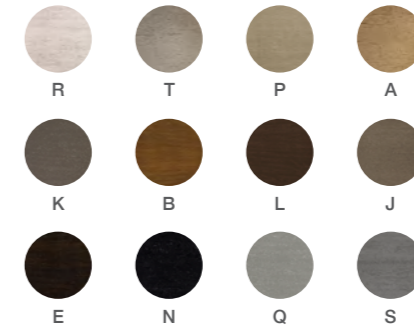

Metal finish / Acabado metálico



**TEN PETITE
UPHOLSTERED CHAIR 300**
poltrona ten petite 300

TN10-300

w 27^{1/2"} D 29^{1/2"} H 30^{3/4"} SH 17^{3/4"}
70 cm 75 cm 78 cm 45 cm

sw 24^{1/2"} sd 20^{3/4"}
62 cm 53 cm

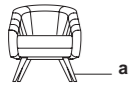
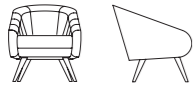

a: wood finish

Wood finish / Acabado madera



**UPHOLSTERED ARM
CHAIR TEN 400**
poltrona ten 400

TN10-400

w 25^{1/2"} D 25^{1/2"} H 30^{3/4"} SH 17^{3/4"}
65 cm 65 cm 78 cm 45 cm

sw 22^{1/2"} sd 20^{1/2"} AH 22^{1/2"}
57 cm 52 cm 57 cm

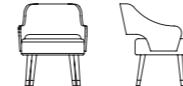

a: base finish b: metal finish

Base finish / Acabado base

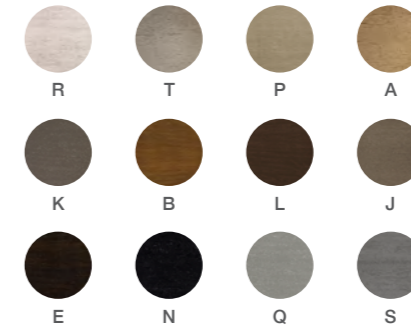

Metal finish / Acabado metálico



OTTOMANS

otomanes



BOLERO OTTOMAN 200
otomán bolero 200



CHOCOLATE OTTOMAN 110
otomán chocolate 110



CARAMELO OTTOMAN 150
otomán caramelo 150



GEM OTTOMAN 101
otomán gem 101



GALAPAGOS STOOL 400
galapagos stool 400



GRAFITO OTTOMAN 110
otomán grafito 110



H OTTOMAN 300
otomán h 300



RUMBA ROUND OTTOMAN 100
otomán redondo rumba 100



TEN OTTOMAN 200
otomán ten 200

Slight color variations may occur while printing tear sheets due to printers pixelation and quality. Product specifications are subject to change due to product development updates. / Ligeras variaciones de color pueden ocurrir en la impresión. Las especificaciones están sujetas a cambios debido a las necesidades del producto.
Dimensions are usually approximated to the nearest quarter inch that will correspond to its metric conversion. / Las medidas generalmente se dan de acuerdo a la conversión métrica correspondiente y con una medida aproximada.

BOLERO QUILTED OTTOMAN 200
otomán bolero 200

BR16-200

w 31^{1/2"} D 31^{1/2"} H 17^{3/4"}
80 cm 80 cm 45 cm

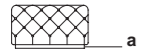
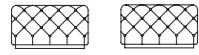

a: wood finish

Wood finish / Acabado madera

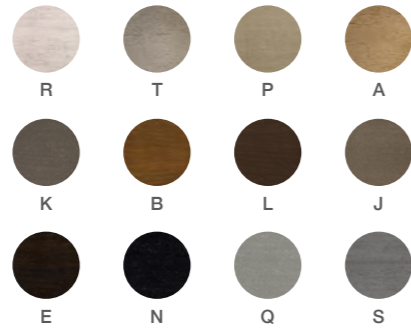

CHOCOLATE OTTOMAN 110
otomán chocolate 110

CH16-110

w 23^{1/2"} D 23^{1/2"} H 17^{3/4"}
60 cm 60 cm 45 cm

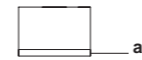
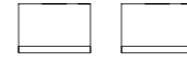

a: wood finish

Wood finish / Acabado madera

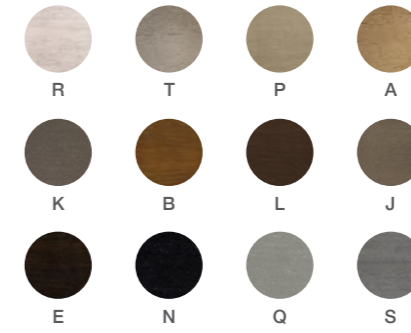

CARAMELO QUILTED OTTOMAN 150
otomán capitoneado caramelo 150

CM16-150

w 47^{1/4"} d 23^{1/2"} h 15"
120 cm 60 cm 38 cm

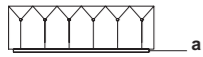
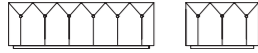
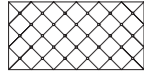

a:wood finish

Wood finish / Acabado madera



GEM OTTOMAN 101 (SWIVEL)
otomán gem 101 (mecanismo giratorio)

GM16-101

w 31^{1/2"} d 31^{1/2"} h 15^{3/4"}
80 cm 80 cm 40 cm



a:wood finish

Wood finish / Acabado madera

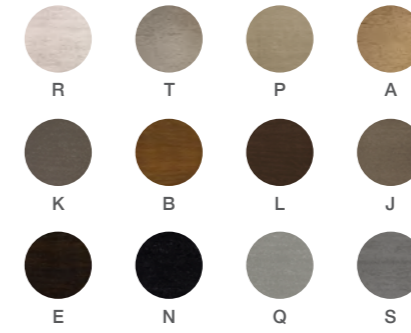



Referential photo. Some products, finishes or fabrics may no longer be available. /
Foto referencial. Algunos productos, acabados o telas podrían ya no estar disponibles.

GALAPAGOS FOOT STOOL 400
galápagos foot stool 400

GS16-400

w 25^{1/4"} D 19^{3/4"} H 16^{1/2"}
64 cm 50 cm 42 cm

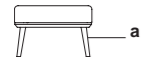

a: wood finish

Wood finish / Acabado madera



Referential photo. Some products, finishes or fabrics may no longer be available. /
Foto referencial. Algunos productos, acabados o telas podrían ya no estar disponibles.

GRAFITO
OTTOMAN 110
otomán grafito 110

GT16-110

W 20^{1/2}" D 20^{1/2}" H 19"
52 cm 52 cm 48 cm

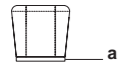
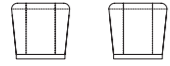

a: wood finish

Wood finish / Acabado madera



H OTTOMAN 300
otomán h 300

HS16-300

W 19^{3/4}" D 19^{3/4}" H 16^{1/2}"
50 cm 50 cm 42 cm

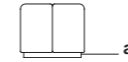
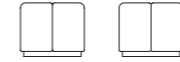

a: wood finish

Wood finish / Acabado madera

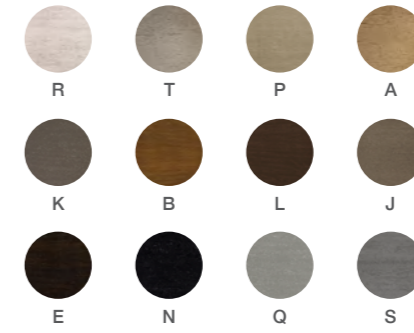

RUMBA OTTOMAN 100
otomán rumba 100

RM16-100

DIAM. 29 1/2" H 15 3/4"
75 cm 40 cm



a: wood finish

Wood finish / Acabado madera



Referential photo. Some products, finishes or fabrics may no longer be available. /
Foto referencial. Algunos productos, acabados o telas podrían ya no estar disponibles.

TEN OTTOMAN 200
otomán ten 200

TN16-200

w 26^{3/4"} D 23^{1/2"} H 17^{3/4"}
68 cm 60 cm 45 cm

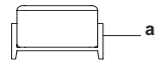
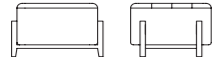
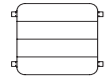

a: wood finish

Wood finish / Acabado madera

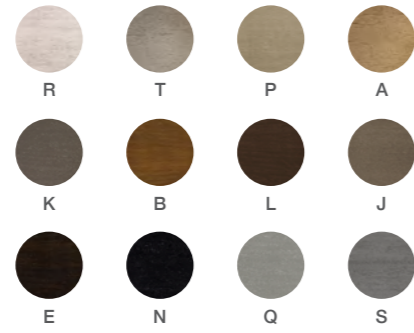

Referential photo. Some products, finishes or fabrics may no longer be available. /
Foto referencial. Algunos productos, acabados o telas podrían ya no estar disponibles.

DAYBEDS

daybeds



BOLERO DAYBED 100
daybed bolero 100



CHOCOLATE DAYBED 100/120
daybed chocolate 100/120



H DAYBED 310
daybed h 310



RUMBA DAYBED 100
daybed rumba 100



TEN DAYBED 100
daybed ten 100



TEN DAYBED 200
daybed ten 200

BOLERO DAYBED 100 daybed bolero 100

BR15-100

w 73^{1/2}" D 27^{1/2}" H 25^{1/2}" SH 17^{3/4}"
187 cm 70 cm 65 cm 45 cm

SW 63^{1/2}" SD 27^{1/2}" AH 25^{1/2}"
161 cm 70 cm 65 cm

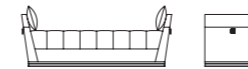
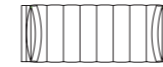

a:leather detail b:decorative hardware c:wood finish

LUMBAR PILLOWS (X2) / COJINES LUMBARES (X2)

w 27^{1/2}" H 13^{3/4}"
70 cm 35 cm

Wood finish / Acabado madera



Leather detail / Detalle cuero



Decorative hardware / Herraje decorativo

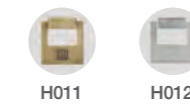

Lumbar pillows included. / Incluye cojines lumbares.

Slight color variations may occur while printing tear sheets due to printers pixelation and quality. Product specifications are subject to change due to product development updates. / Ligeras variaciones de color pueden ocurrir en la impresión. Las especificaciones están sujetas a cambios debido a las necesidades del producto.

Dimensions are usually approximated to the nearest quarter inch that will correspond to its metric conversion. / Las medidas generalmente se dan de acuerdo a la conversión métrica correspondiente y con una medida aproximada.

CHOCOLATE DAYBED 100
daybed chocolate 100

CH15-100

W 82^{3/4"} D 33^{1/2"} H* 25^{1/2"} SH 17^{3/4"}
210 cm 85 cm 65 cm 45 cm

SW 69^{1/4"}
176 cm

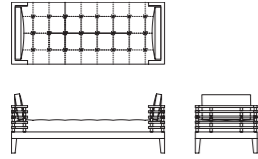

a:wood finish

LUMBAR PILLOWS (X2) / COJINES LUMBARES (X2)

W 29^{1/2"} H 15^{3/4"} D 3^{1/4"}
75 cm 40 cm 8 cm

CHOCOLATE DAYBED 120
daybed chocolate 120

CH15-120

W 67" D 27^{1/2"} H* 25^{1/2"} SH 17^{3/4"}
170 cm 70 cm 65 cm 45 cm

SW 53^{1/2"}
136 cm

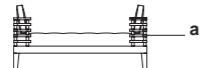
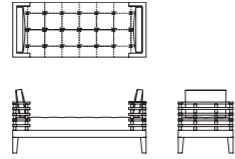

a:wood finish

LUMBAR PILLOWS (X2) / COJINES LUMBARES (X2)

W 25^{1/2"} H 13^{3/4"} D 3^{1/4"}
65 cm 35 cm 8 cm

Wood finish / Acabado madera



H DAYBED 310
daybed h 310

HS15-310

W 59" D 25^{1/2"} H 16^{1/2"}
150 cm 65 cm 42 cm

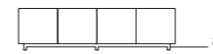
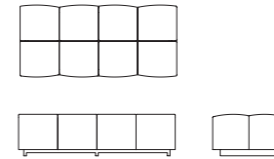

a:wood finish

Wood finish / Acabado madera

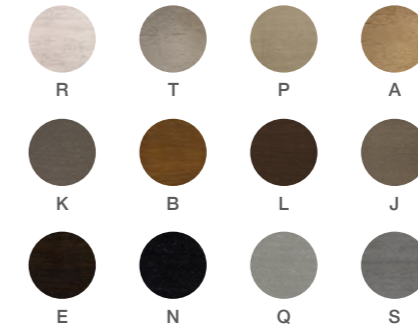

Lumbar pillows included. / Incluye cojines lumbares.

* (H) Dimensions does not include lumbar pillows. / * (H) Las dimensiones no incluyen los cojines lumbares.

RUMBA DAYBED 100
daybed rumba 100

RM15-100

w 67" D 23 1/2" H 17 3/4"
170 cm 60 cm 45 cm

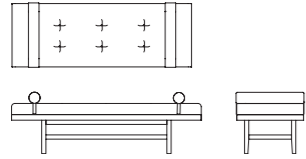

a: wood finish

BOLSTER PILLOWS (X2) / COJINES CARAMELO (X2)

w 23 1/2" D 2 1/4"
60 cm 6 cm

Wood finish / Acabado madera

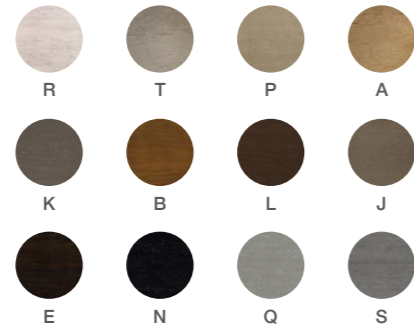

Bolster pillows included. / Incluye cojines caramelo.



Referential photo. Some products, finishes or fabrics may no longer be available. / Foto referencial. Algunos productos, acabados o telas podrían ya no estar disponibles.

TEN DAYBED 100
daybed ten 100

TN15-100

w 63" D 27 1/2" H 17 3/4"
160 cm 70 cm 45 cm

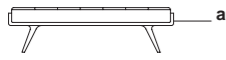
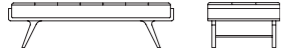
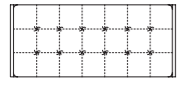

a: wood finish

Wood finish / Acabado madera

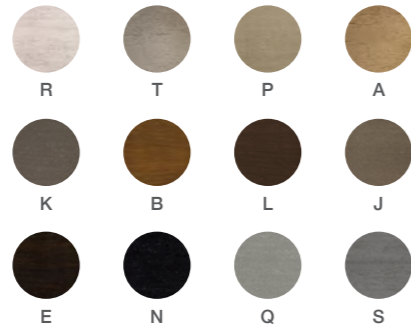

TEN DAYBED 200
daybed ten 200

TN15-200

w 59" D 23 1/2" H 17 3/4"
150 cm 60 cm 45 cm

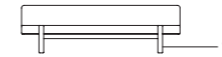
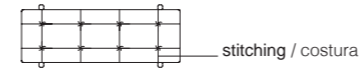
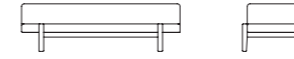

a: wood finish

Wood finish / Acabado madera

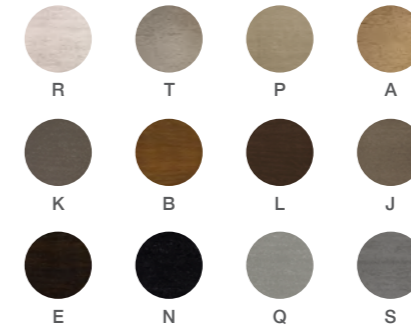



COCKTAIL TABLES

mesas centrales



AFRICA COCKTAIL TABLE 478
mesa central áfrica 478



AFRICA COCKTAIL TABLE 481
mesa central áfrica 481



AFRICA COCKTAIL TABLES (LOW)
mesas centrales áfrica (bajas)



AFRICA COCKTAIL TABLES (HIGH)
mesas centrales áfrica (altas)



AH SIGNATURE COCKTAIL TABLE 100
mesa central ah signature 100



AH SIGNATURE COCKTAIL TABLE 101
mesa central ah signature 101



BOLERO COCKTAIL TABLE 101
mesa central bolero 101



BOLERO COCKTAIL TABLE 200
mesa central bolero 200



BOLERO COCKTAIL TABLE 201
mesa central bolero 201

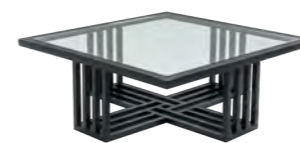

CHOCOLATE COCKTAIL TABLE 200
mesa central chocolate 200



CHOCOLATE COCKTAIL TABLE 300
mesa central chocolate 300



GEM COCKTAIL TABLE 100
mesa central gem 100

Slight color variations may occur while printing tear sheets due to printers pixelation and quality. Product specifications are subject to change due to product development updates. / Ligeras variaciones de color pueden ocurrir en la impresión. Las especificaciones están sujetas a cambios debido a las necesidades del producto.

Dimensions are usually approximated to the nearest quarter inch that will correspond to its metric conversion. / Las medidas generalmente se dan de acuerdo a la conversión métrica correspondiente y con una medida aproximada.

COCKTAIL TABLES

mesas centrales

COCKTAIL TABLES

mesas centrales



GEM COCKTAIL TABLE 101
mesa central gem 101



GEM COCKTAIL TABLE 110
mesa central gem 110



GEM COCKTAIL TABLE 111
mesa central gem 111



GALAPAGOS COCKTAIL TABLE 301
mesa central galápagos 301



GALAPAGOS COCKTAIL TABLE 310
mesa central galápagos 310



GALAPAGOS COCKTAIL TABLE 311
mesa central galápagos 311



GEM COCKTAIL TABLE 200
mesa central gem 200



GEM COCKTAIL TABLE 201
mesa central gem 201



GEM COCKTAIL TABLE 210
mesa central gem 210



GALAPAGOS COCKTAIL TABLE 401
mesa central galápagos 401



H COCKTAIL TABLE 200
mesa central h 200



RUMBA COCKTAIL TABLE 200
mesa central rumba 200



GEM COCKTAIL TABLE 211
mesa central gem 211



GALAPAGOS COCKTAIL TABLE 100
mesa central galápagos 100



GALAPAGOS COCKTAIL TABLE 110
mesa central galápagos 110



RUMBA COCKTAIL TABLE 400
mesa central rumba 400



RUMBA COCKTAIL TABLE 401
mesa central rumba 401



RUMBA COCKTAIL TABLE 410
mesa central rumba 410



GALAPAGOS COCKTAIL TABLE 200
mesa central galápagos 200



GALAPAGOS COCKTAIL TABLE 210
mesa central galápagos 210



GALAPAGOS COCKTAIL TABLE 300
mesa central galápagos 300



TEN COCKTAIL TABLES 100/111/120
mesas centrales ten 100/111/120

Slight color variations may occur while printing tear sheets due to printers pixelation and quality. Product specifications are subject to change due to product development updates. / Ligeras variaciones de color pueden ocurrir en la impresión. Las especificaciones están sujetas a cambios debido a las necesidades del producto.

Dimensions are usually approximated to the nearest quarter inch that will correspond to its metric conversion. / Las medidas generalmente se dan de acuerdo a la conversión métrica correspondiente y con una medida aproximada.

Slight color variations may occur while printing tear sheets due to printers pixelation and quality. Product specifications are subject to change due to product development updates. / Ligeras variaciones de color pueden ocurrir en la impresión. Las especificaciones están sujetas a cambios debido a las necesidades del producto.

Dimensions are usually approximated to the nearest quarter inch that will correspond to its metric conversion. / Las medidas generalmente se dan de acuerdo a la conversión métrica correspondiente y con una medida aproximada.

AFRICA COCKTAIL TABLE 478
 mesa central África 478

AF19-478

w 35 1/2" D 35 1/2" H 11 3/4"
 90 cm 90 cm 30 cm

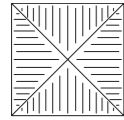

a: wood finish

Wood finish / Acabado madera



AFRICA COCKTAIL TABLE 481 (STONE STOP)
 mesa central África 481 (top piedra)

AF19-481

w 35 1/2" D 35 1/2" H 11 3/4"
 90 cm 90 cm 30 cm

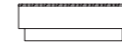
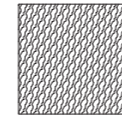

a: stone top b: base finish

Stone top / Top piedra

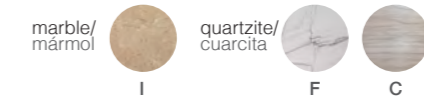

Base finish / Acabado base



AFRICA COCKTAIL TABLE 500
 mesa central áfrica 500

AF19-500

W 35 1/2" D 35 1/2" H 11 3/4"
 90 cm 90 cm 30 cm

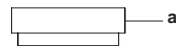
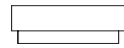
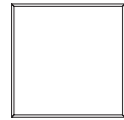

a: wood finish

AFRICA COCKTAIL TABLE 510
 mesa central áfrica 510

AF19-510

W 23 1/2" D 23 1/2" H 11 3/4"
 60 cm 60 cm 30 cm

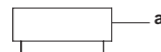
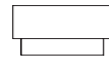
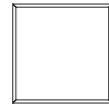

a: wood finish

Wood finish / Acabado madera



AFRICA COCKTAIL TABLE 520
 mesa central áfrica 520

AF19-520

W 35 1/2" D 23 1/2" H 11 3/4"
 90 cm 60 cm 30 cm

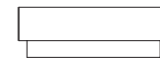

a: wood finish

AFRICA COCKTAIL TABLE 530
 mesa central áfrica 530

AF19-530

W 59" D 23 1/2" H 11 3/4"
 150 cm 60 cm 30 cm

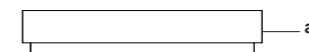
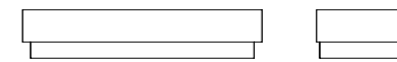

a: wood finish

Wood finish / Acabado madera



AFRICA COCKTAIL TABLE 505 (MIRROR TOP)
 mesa central África 505 (top espejo)

AF19-505

w 35^{1/2"} d 35^{1/2"} H 11^{3/4"}
 90 cm 90 cm 30 cm

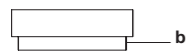
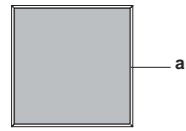
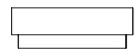
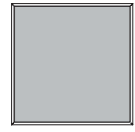

a:mirror top b:base finish

AFRICA COCKTAIL TABLE 515 (MIRROR TOP)
 mesa central África 515 (top espejo)

AF19-515

w 23^{1/2"} d 23^{1/2"} H 11^{3/4"}
 60 cm 60 cm 30 cm

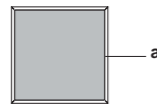
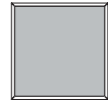

a:mirror top b:base finish

Base finish / Acabado base

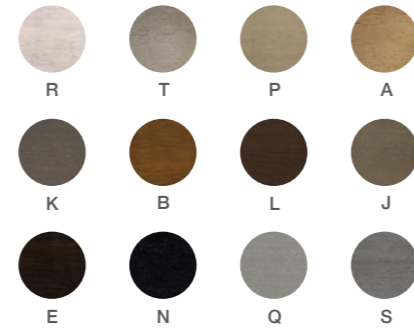

Mirror top / Top espejo

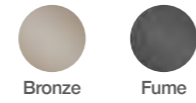

AFRICA COCKTAIL TABLE 525 (MIRROR TOP)
 mesa central África 525 (top espejo)

AF19-525

w 35^{1/2"} d 23^{1/2"} H 11^{3/4"}
 90 cm 60 cm 30 cm

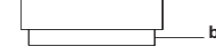
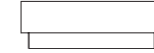

a:mirror top b:base finish

AFRICA COCKTAIL TABLE 535 (MIRROR TOP)
 mesa central África 535 (top espejo)

AF19-535

w 59" d 23^{1/2"} H 11^{3/4"}
 150 cm 60 cm 30 cm



a:mirror top b:base finish

Base finish / Acabado base



Mirror top / Top espejo

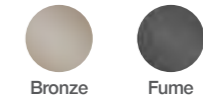

**AFRICA COCKTAIL TABLE 501
(STONE TOP)**
mesa central áfrica 501
(top piedra)

AF19-501

w 35^{1/2}" D 35^{1/2}" H 11^{3/4}"
90 cm 90 cm 30 cm

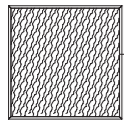
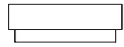
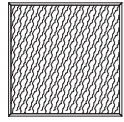

a:stone top b:base finish

**AFRICA COCKTAIL TABLE 531
(STONE TOP)**
mesa central áfrica 531
(top de piedra)

AF19-531

w 59" D 23^{1/2}" H 11^{3/4}"
150 cm 60 cm 30 cm

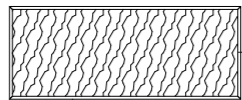
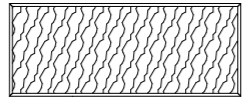

a:stone top b:base finish

Stone top / Top piedra



Base finish / Acabado base



**AFRICA COCKTAIL TABLE 601
(STONE TOP)**
mesa central africa 601
(top piedra)

AF19-601

w 35^{1/2}" D 35^{1/2}" H 17"
90 cm 90 cm 43 cm

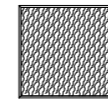
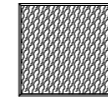

a:stone top b:wood finish

Stone top / Top piedra



Base finish / Acabado base

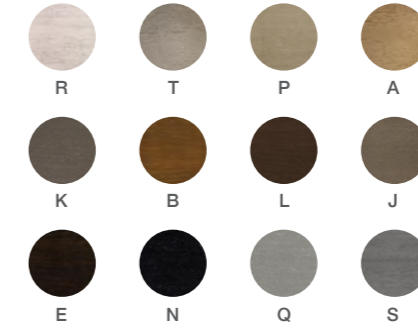

AFRICA COCKTAIL TABLE 615
(MIRROR TOP)
mesa central africa 615
(top espejo)

AF19-615

w 23^{1/2"} D 23^{1/2"} H 17"
60 cm 60 cm 43 cm

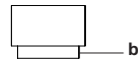
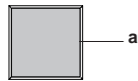

a:mirror top b:wood finish

AFRICA COCKTAIL TABLE 625
(MIRROR TOP)
mesa central africa 625
(top espejo)

AF19-625

w 35^{1/2"} D 23^{1/2"} H 17"
90 cm 60 cm 43 cm



a:mirror top b:wood finish

Base finish / Acabado base



Mirror top / Top espejo

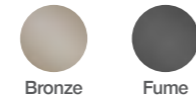

AFRICA COCKTAIL TABLE 630
mesa central africa 630

AF19-630

w 59" D 23^{1/2"} H 17"
150 cm 60 cm 43 cm

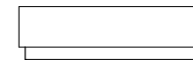

a:wood finish

Wood finish / Acabado madera

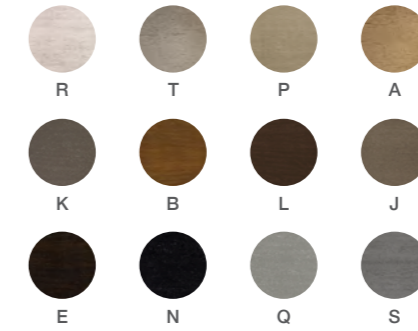

Build your own! | ¡Constrúyalo usted mismo!

Here you can find a suggested layout, but feel free to create a new one yourself.
Aquí encontrará una combinación sugerida, sin embargo le invitamos a que cree una nueva usted mismo.



Wood / Madera



Stone / Piedra



Mirror / Espejo

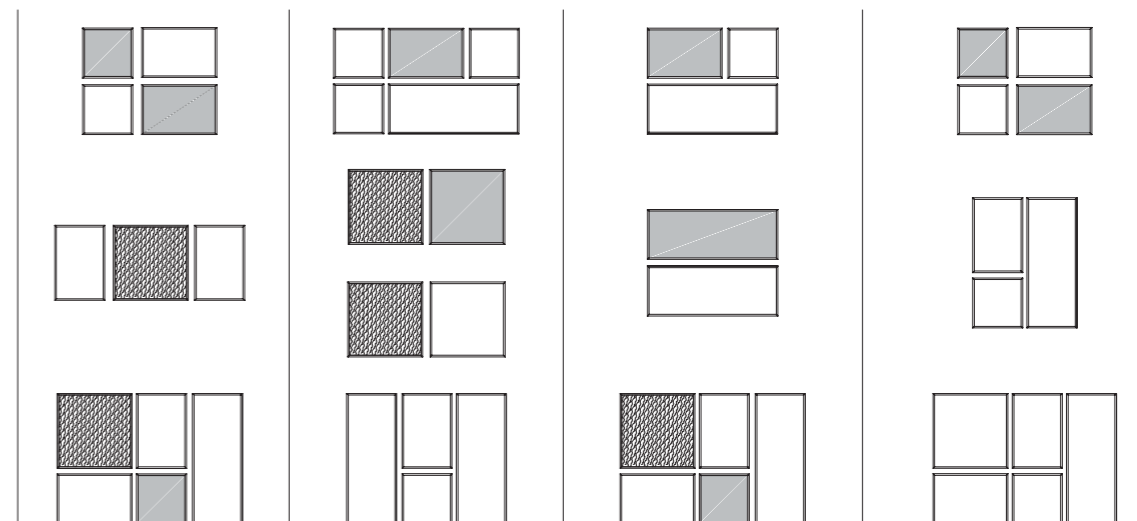

AH SIGNATURE COCKTAIL TABLE 100

mesa central ah signature 100

AH19-100

DIAM 50" H 16 1/2"
127 cm 42 cm

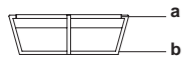
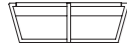
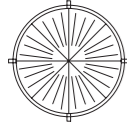

a:top finish **b:**base finish

Top finish / Acabado top
Base finish / Acabado base

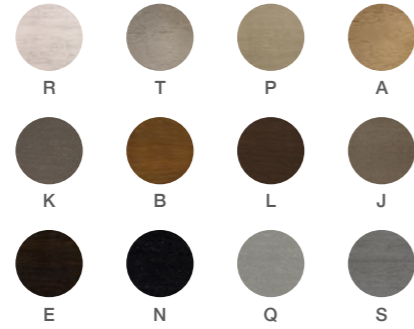

AH SIGNATURE COCKTAIL TABLE 101 (STONE TOP)

mesa central ah signature 101 (top piedra)

AH19-101

DIAM 50" H 16 1/2"
127 cm 42 cm

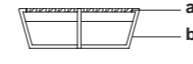
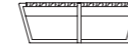
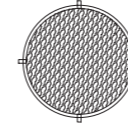

a:stone top **b:**base finish

Stone top / Top piedra

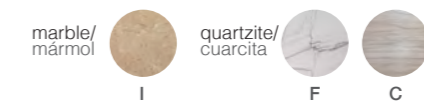

Base finish / Acabado base

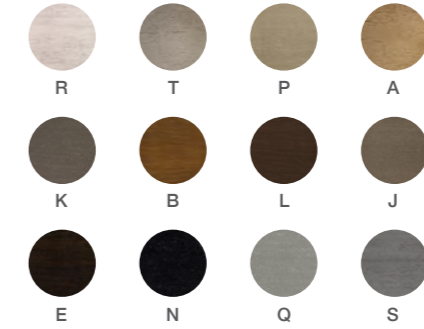

BOLERO COCKTAIL TABLE 101 (STONE TOP)
 mesa central bolero 101 (top piedra)

BR19-101

DIAM. 47^{1/4}" H 15^{1/4}"
 120 cm 39 cm

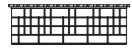
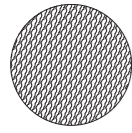

a:stone top **b:**metal finish

Stone top / Top piedra

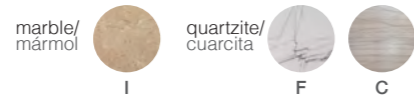

Metal finish / Acabado metal



BOLERO COCKTAIL TABLE 200
 mesa central bolero 200

BR19-200

w 51^{1/4}" D 35^{1/2}" H 17"
 130 cm 90 cm 43 cm

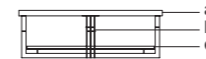
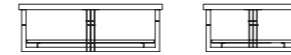
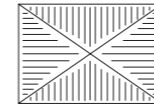

a:wood finish **b:**metal finish **c:**high gloss finish



COMBINATION OPTIONS / OPCIÓN DE COMBINACIONES

Wood finish / Acabado madera

High gloss finish / Acabado high gloss



Metal finish / Acabado metal

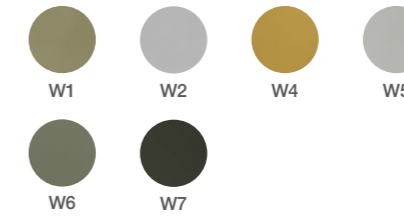

**BOLERO COCKTAIL TABLE
201 (STONE TOP)**
mesa central bolero 201
(top piedra)

BR19-201

w 51^{1/4}" D 35^{1/2}" H 17"
130 cm 90 cm 43 cm

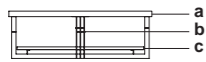
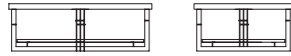
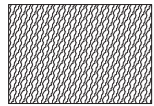

a:stone top b:metal finish c:high gloss finish

Stone top / Top piedra

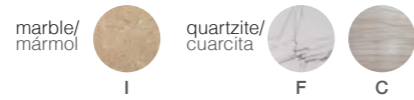

Metal finish / Acabado metal



High gloss finish / Acabado high gloss



**CHOCOLATE 200 COCKTAIL
TABLE BASE (GLASS TOP)**
mesa central chocolate 200
(top de vidrio)

CH19-200

w 47^{1/4}" D 47^{1/4}" H 15^{3/4}"
120 cm 120 cm 40 cm

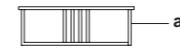
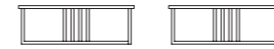

a:wood finish

Wood finish / Acabado madera

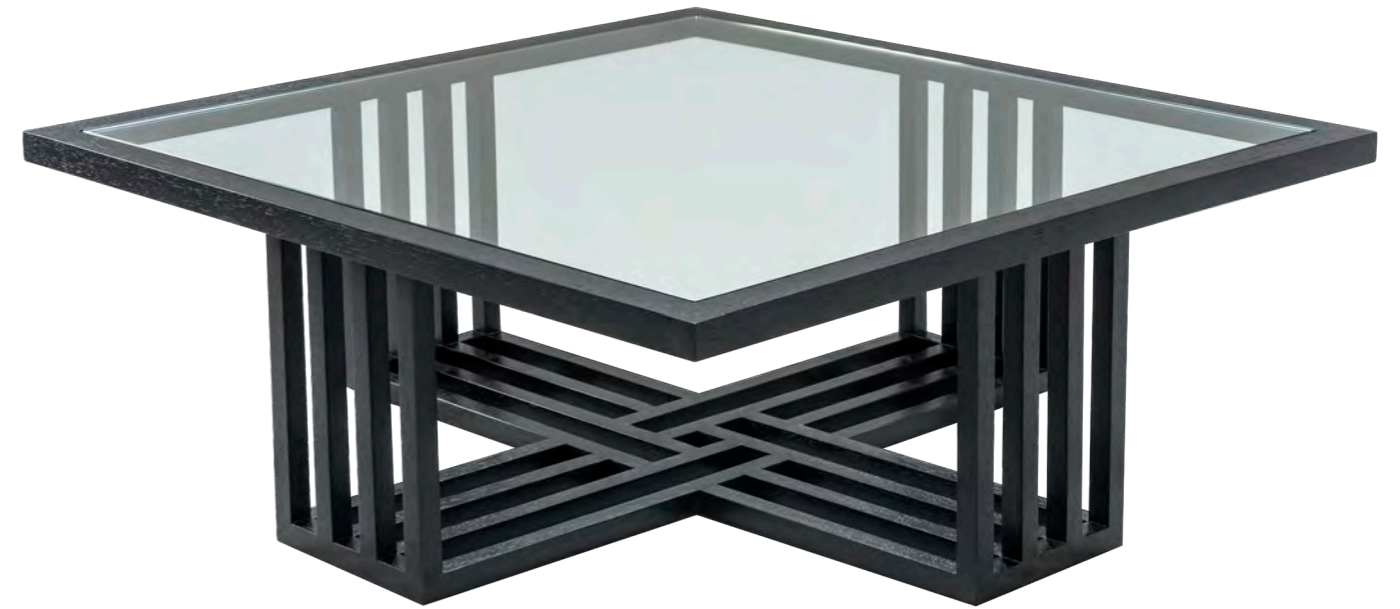
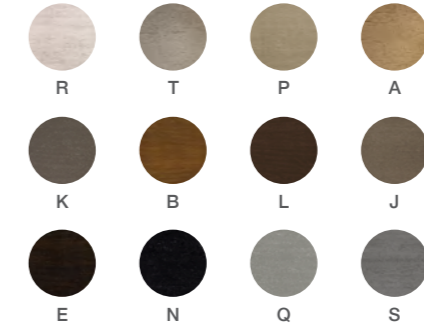

Glass top included / Incluye top de vidrio

CHOCOLATE COCKTAIL TABLE 300 (GLASS TOP)
 mesa central chocolate 300 (top de vidrio)

CH19-300

W 47^{1/4"} D 47^{1/4"} H 15^{3/4"}
 120 cm 120 cm 40 cm

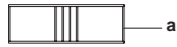
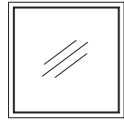

a:metal finish

Metal finish / Acabado metal



Glass top included / Incluye top de vidrio

LIVING ROOM | SALA

GEM COCKTAIL TABLE 100
 mesa central gem 100

GM19-100

W 35^{1/2"} D 35^{1/2"} H 20^{3/4"}
 90 cm 90 cm 53 cm

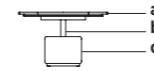

a:top finish b:metal finish c:base finish

Top finish / Acabado top
 Base finish / Acabado base

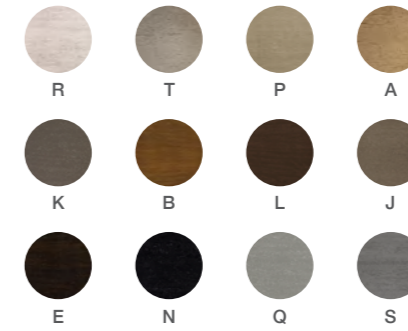

Metal finish / Acabado metal



Tables sold separately. / Las mesas se venden por separado.
 One piece metallic structure. / Estructura de metal en una pieza.

LIVING ROOM | SALA

GEM COCKTAIL TABLE 101
(STONE TOP)
 mesa central gem 101
 (top piedra)

GM19-101

w 35^{1/2}" D 35^{1/2}" H 20^{3/4}"
 90 cm 90 cm 53 cm

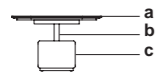
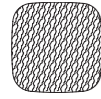

a:stone top b:metal finish c:base finish

Stone top / Top piedra



Base finish / Acabado base



Metal finish / Acabado metal



Tables sold separately. / Las mesas se venden por separado.
 One piece metallic structure / Estructura de metal en una pieza



Referential photo. Some products, finishes or fabrics may no longer be available. /
 Foto referencial. Algunos productos, acabados o telas podrían ya no estar disponibles.

GEM COCKTAIL TABLE 110
 mesa central gem 110

GM19-110

w 43^{1/4"} D 43^{1/4"} H 18^{1/2"}
 110 cm 110 cm 47 cm

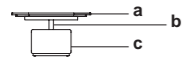

a:top finish b:metal finish c:base finish

Top finish / Acabado top
 Base finish / Acabado base



Metal finish / Acabado metal



One piece metallic structure. / Estructura de metal en una pieza.

GEM COCKTAIL TABLE 111
(STONE TOP)
 mesa central gem 111
 (top piedra)

GM19-111

w 43^{1/4"} D 43^{1/4"} H 18^{1/2"}
 110 cm 110 cm 47 cm

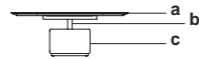
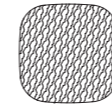

a:stone top b:metal finish c:base finish

Stone top / Top piedra



Base finish / Acabado base

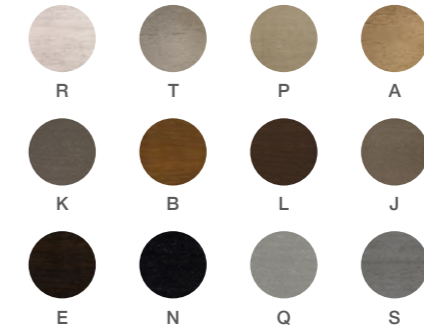

Metal finish / Acabado metal



Tables sold separately. / Las mesas se venden por separado.
 One piece metallic structure. / Estructura de metal en una pieza.



Referential photo. Some products, finishes or fabrics may no longer be available. /
Foto referencial. Algunos productos, acabados o telas podrían ya no estar disponibles.

LIVING ROOM | SALA

 ADRIANA HOYOS

GEM COCKTAIL TABLE 200
 mesa central gem 200

GM19-200

w 63" D 31 1/2" H 19"
 160 cm 80 cm 48 cm

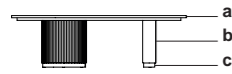
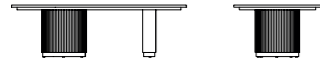
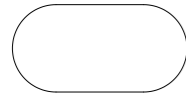

a:top finish b:base finish c:wooden detail

Top finish / Acabado madera
 Base finish / Acabado madera
 Wooden detail / Detalle madera



Tables sold separately. / Las mesas se venden por separado.

GEM COCKTAIL TABLE 201
(STONE TOP)
 mesa central gem 201
 (top piedra)

GM19-201

w 63" D 31 1/2" H 19"
 160 cm 80 cm 48 cm

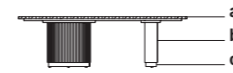
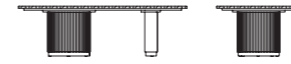
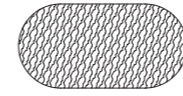

a:stone top b:base finish c:wooden detail

Stone top / Top piedra

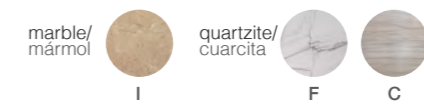

Base finish / Acabado base
 Wooden detail / Detalle madera

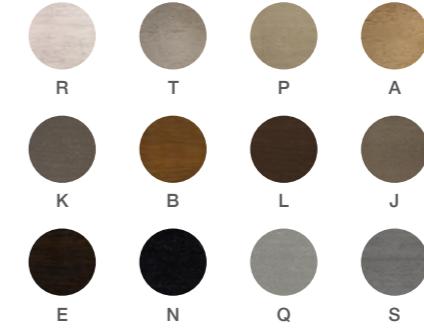

Tables sold separately. / Las mesas se venden por separado.



Referential photo. Some products, finishes or fabrics may no longer be available. /
Foto referencial. Algunos productos, acabados o telas podrían ya no estar disponibles.

LIVING ROOM | SALA

 ADRIANA HOYOS

GEM COCKTAIL TABLE 210
 mesa central gem 210

GM19-210

w 63" D 31 1/2" H 16 1/2"
 160 cm 80 cm 42 cm

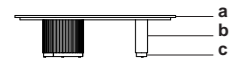
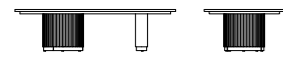

a:top finish b:base finish c:wooden finish

Top finish / Acabado madera
 Base finish / Acabado madera
 Wooden detail / Detalle madera

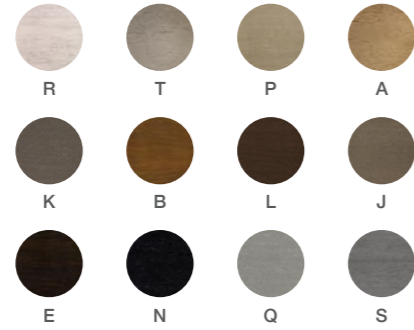

GEM COCKTAIL TABLE 211
 (STONE TOP)
 mesa central gem 211
 (top piedra)

GM19-211

w 63" D 31 1/2" H 16 1/2"
 160 cm 80 cm 42 cm

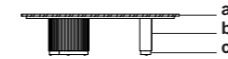
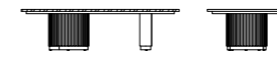
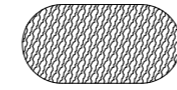

a:stone top b:base finish c:wooden finish

Stone top / Top piedra

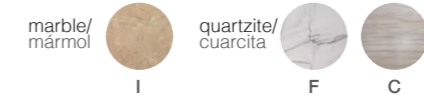

Base finish / Acabado base
 Wooden detail / Detalle madera

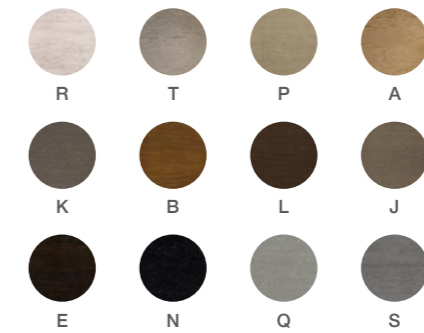

Tables sold separately. / Las mesas se venden por separado.

Tables sold separately. / Las mesas se venden por separado.

GALAPAGOS COCKTAIL TABLE 100 (GLASS TOP)
 mesa central galápagos 100 (top vidrio)

GS19-100

DIAM 47^{1/4"} H 13^{3/4"}
 120 cm 35 cm



a: wood finish

Wood finish / Acabado madera



Tables sold separately. / Las mesas se venden por separado.
 Glass top included / Incluye top de vidrio

LIVING ROOM | SALA

GALAPAGOS NESTING COCKTAIL TABLE 110
 mesa central nesting galápagos 110

GS19-110

DIAM 35^{1/2"} H 16^{1/2"}
 90 cm 42 cm

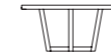
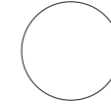

a: wood finish

Wood finish / Acabado madera

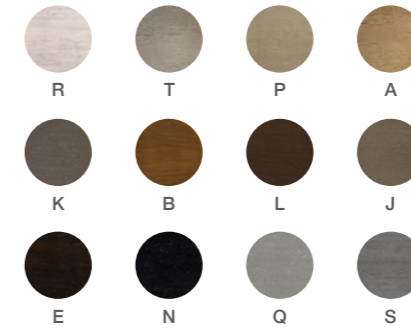

Tables sold separately. / Las mesas se venden por separado.

LIVING ROOM | SALA



Referential photo. Some products, finishes or fabrics may no longer be available. /
Foto referencial. Algunos productos, acabados o telas podrían ya no estar disponibles.

GALAPAGOS COCKTAIL TABLE 200
 mesa central galápagos 200

GS19-200

w 55" D 31 1/2" H 15 3/4"
 140 cm 80 cm 40 cm

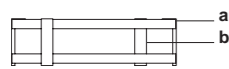
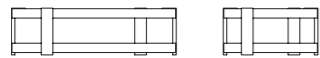
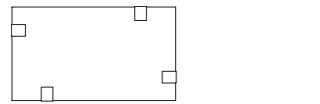

a: wood finish b: wooden detail

Wood finish / Acabado madera
 Wooden detail / Detalle madera



Referential photo. Some products, finishes or fabrics may no longer be available. /
 Foto referencial. Algunos productos, acabados o telas podrían ya no estar disponibles.

**GALAPAGOS COCKTAIL
TABLE 210**
mesa central
galápagos 210

GS19-210

w 59" d 59" h 15³/₄"
150 cm 150 cm 40 cm

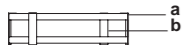
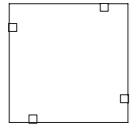

a:wood finish b:wooden detail

Wood finish / Acabado madera
Wooden detail / Detalle madera

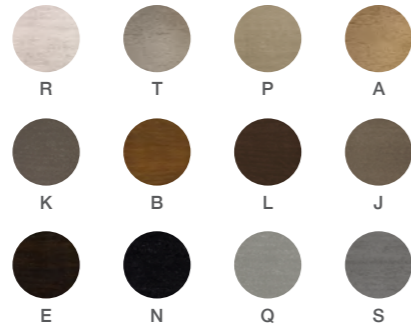

Referential photo. Some products, finishes or fabrics may no longer be available. /
Foto referencial. Algunos productos, acabados o telas podrían ya no estar disponibles.

**GALAPAGOS
COCKTAIL TABLE 300**
mesa central galápagos 300

GS19-300

w 63" D 35 1/2" H 13 3/4"
160 cm 90 cm 35 cm

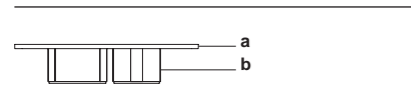
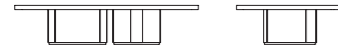
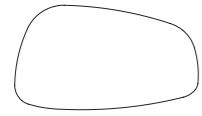

a:top finish b:base finish

Top finish / Acabado top
Base finish / Acabado base



**GALAPAGOS
COCKTAIL TABLE 301
(STONE TOP)**
mesa central galápagos 301
(top piedra)

GS19-301

w 63" D 35 1/2" H 13 3/4"
160 cm 90 cm 35 cm

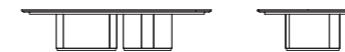
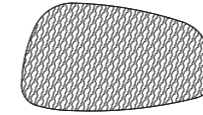

a:stone top b:base finish

Stone top / Top piedra



Base finish / Acabado base

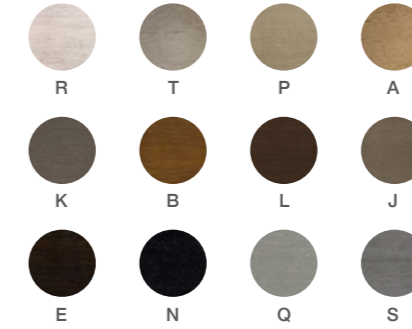

Tables sold separately. / Las mesas se venden por separado.



Referential photo. Some products, finishes or fabrics may no longer be available. /
Foto referencial. Algunos productos, acabados o telas podrían ya no estar disponibles.

**GALAPAGOS
COCKTAIL TABLE 310**
mesa central galápagos 310

GS19-310

W 47^{1/4"} D 23^{1/2"} H 16^{1/2"}
120 cm 60 cm 42 cm

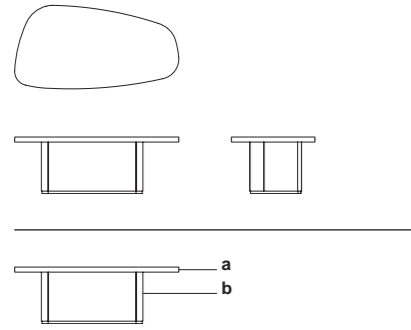

a:top finish **b:**base finish

Top finish / Acabado top
Base finish / Acabado base



Tables sold separately. / Las mesas se venden por separado.

**GALAPAGOS COCKTAIL
TABLE 311 (STONE TOP)**
mesa central galápagos 311
(top piedra)

GS19-311

W 47^{1/4"} D 23^{1/2"} H 16^{1/2"}
120 cm 60 cm 42 cm

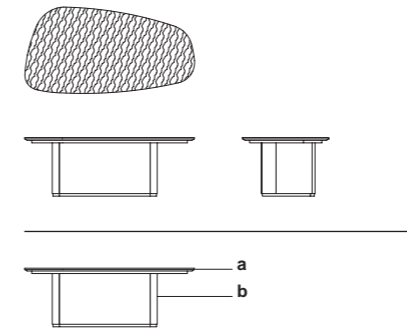

a:stone top **b:**base finish

Stone top / Top piedra

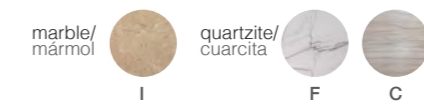

Base finish / Acabado base

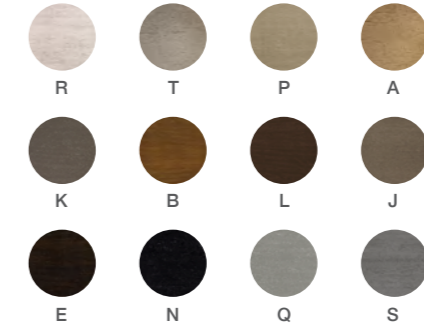



Referential photo. Some products, finishes or fabrics may no longer be available. /
Foto referencial. Algunos productos, acabados o telas podrían ya no estar disponibles.

LIVING ROOM | SALA

 ADRIANA HOYOS

**GALAPAGOS
COCKTAIL TABLE 401
(STONE TOP)**

mesa central galápagos 401
(top piedra)

GS19-401

W 57" D 41 1/4" H 16 1/2"
145 cm 105 cm 42 cm

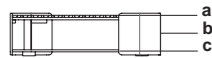
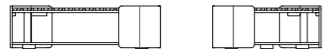
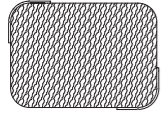

a:stone top b:wood finish c:high gloss finish

Stone top / Top piedra

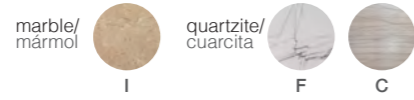

Wood finish / Acabado madera

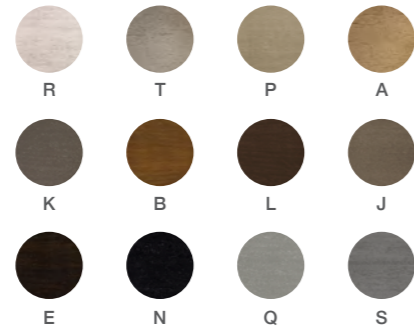

High gloss finish / Acabado high gloss



Referential photo. Some products, finishes or fabrics may no longer be available. /
Foto referencial. Algunos productos, acabados o telas podrían ya no estar disponibles.

H COCKTAIL TABLE 200
 mesa central h 200

HS19-200

w 43^{1/4"} D 27^{1/2"} H 13^{3/4"}
 110 cm 70 cm 35 cm

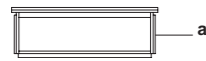
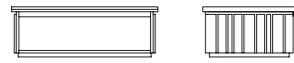

a:wood finish

Wood finish / Acabado madera



RUMBA COCKTAIL TABLE 200
 mesa central rumba 200

RM19-200

w 56^{3/4"} D 36^{1/4"} H 17^{1/4"}
 144 cm 92 cm 44 cm

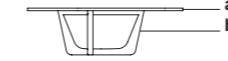
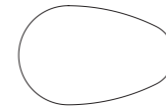

a:top finish b:base finish

Top finish / Acabado top
 Base finish / Acabado base

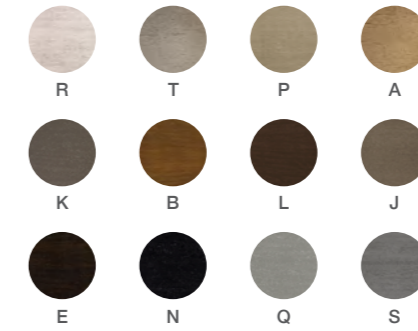

RUMBA COCKTAIL TABLE 400
 mesa central rumba 400

RM19-400

w 51^{1/4}" d 35^{1/2}" h 15"
 130 cm 90 cm 38 cm

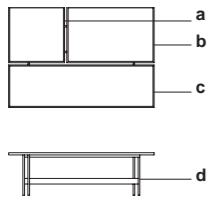
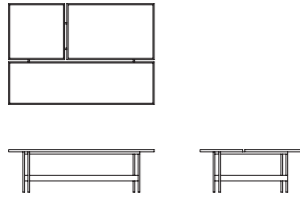

a: small wood top **b:** medium wood top
c: big wood top **d:** metal finish

Big wood top / Top madera grande
 Medium wood top / Top madera mediano
 Small wood top / Top madera pequeño

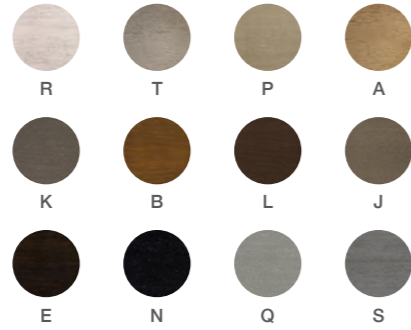

Metal finish / Acabado metal



Referential photo. Some products, finishes or fabrics may no longer be available. /
 Foto referencial. Algunos productos, acabados o telas podrían ya no estar disponibles.

**RUMBA COCKTAIL
TABLE 401**
mesa central rumba 401

RM19-401

w 51^{1/4"} d 35^{1/2"} h 15"
130 cm 90 cm 38 cm

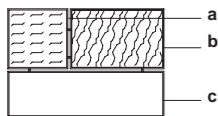
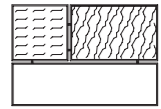

a:leather top **b:**stone top
c:big wood top **d:**metal finish

Leather top / Top cuero



Metal finish / Acabado metal



Stone top / Top piedra

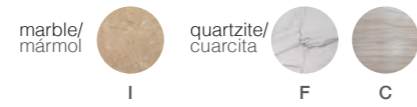

Big wood top / Top madera grande



Referential photo. Some products, finishes or fabrics may no longer be available. /
Foto referencial. Algunos productos, acabados o telas podrían ya no estar disponibles.

RUMBA COCKTAIL TABLE 410
 mesa central rumba 410

RM19-410

DIAM 31¹/₂" H 17³/₄"
 80 cm 45 cm

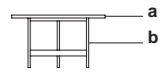
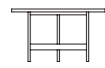
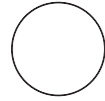

a:top finish **b:**metal finish

Top finish / Acabado top

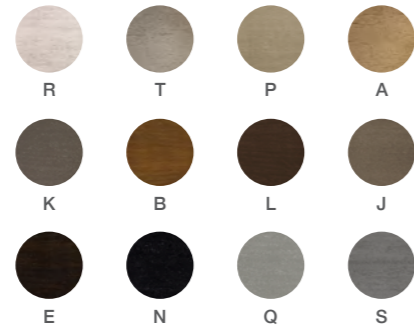

Metal finish / Acabado metal



TEN LARGE COCKTAIL TABLE 100
 mesa central grande ten 100

TN19-100

w 37³/₄" D 41¹/₄" H 15³/₄"
 96 cm 105 cm 40 cm

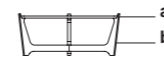

a:top finish **b:**base finish

Top finish / Acabado top
 Base finish / Acabado base



Tables sold separately. / Las mesas se venden por separado.

TEN MEDIUM COCKTAIL TABLE 111
(INSERT GLASS TOP)
 mesa central mediana
 ten 111 (vidrio inserto)

TN19-111

w 27^{1/2}" D 30" H 18"
 70 cm 76 cm 46 cm

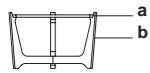
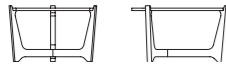
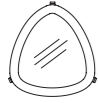

a:top finish **b:**base finish

Top finish / Acabado top
 Base finish / Acabado base

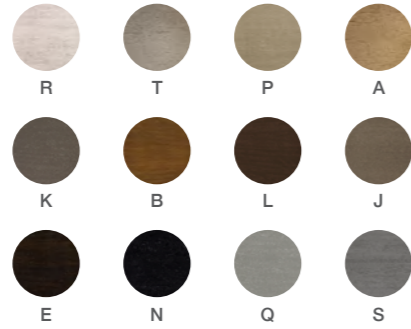

Tables sold separately. / Las mesas se venden por separado.
 Glass top included / Incluye top de vidrio

TEN SMALL COCKTAIL TABLE 120
 mesa central pequeña
 ten 120

TN19-120

w 20^{1/2}" D 21^{1/4}" H 20^{1/2}"
 52 cm 54 cm 52 cm

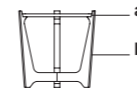
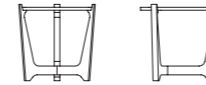

a:top finish **b:**base finish

Top finish / Acabado top
 Base finish / Acabado base

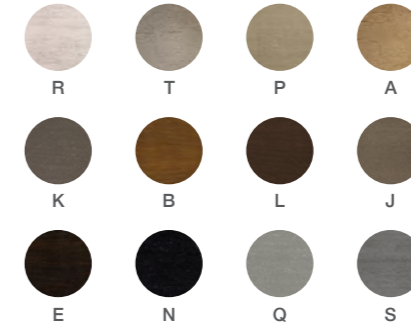

Tables sold separately. / Las mesas se venden por separado.

END TABLES

mesas auxiliares



AFRICA END TABLE 401/403
mesa auxiliar africa 401/403



BOLERO END TABLE 100
mesa auxiliar bolero 100



BOLERO END TABLE 101
mesa auxiliar bolero 101



GALAPAGOS END TABLE 100
mesa auxiliar galápagos 100



GALAPAGOS END TABLE 200
mesa auxiliar galápagos 200



GALAPAGOS END TABLE 300
mesa auxiliar galápagos 300



BOLERO END TABLE 111
mesa auxiliar bolero 111



BOLERO END TABLE 200
mesa auxiliar bolero 200



BOLERO END TABLE 210
mesa auxiliar bolero 210



GALAPAGOS END TABLE 301
mesa auxiliar galápagos 301



GALAPAGOS END TABLE 310
mesa auxiliar galápagos 310



GALAPAGOS END TABLE 311
mesa auxiliar galápagos 311



CHOCOLATE END TABLE 200
mesa auxiliar chocolate 200



CHOCOLATE END TABLE 210
mesa auxiliar chocolate 210



GEM END TABLE 101
mesa auxiliar gem 101



GALAPAGOS END TABLE 750
mesa auxiliar galápagos 750



RUMBA END TABLE 100
mesa auxiliar rumba 100



RUMBA END TABLE 101
mesa auxiliar rumba 101



GEM END TABLE 201
mesa auxiliar gem 201



GEM NESTING SIDE TABLE 300
mesa auxiliar nesting gem 300



GEM LOW BISTRO TABLE 401
mesa baja bistro gem 401



RUMBA END TABLE 110
mesa auxiliar rumba 110

Slight color variations may occur while printing tear sheets due to printers pixelation and quality. Product specifications are subject to change due to product development updates. / Ligeras variaciones de color pueden ocurrir en la impresión. Las especificaciones están sujetas a cambios debido a las necesidades del producto.

Dimensions are usually approximated to the nearest quarter inch that will correspond to its metric conversion. / Las medidas generalmente se dan de acuerdo a la conversión métrica correspondiente y con una medida aproximada.

END TABLES

mesas auxiliares

Slight color variations may occur while printing tear sheets due to printers pixelation and quality. Product specifications are subject to change due to product development updates. / Ligeras variaciones de color pueden ocurrir en la impresión. Las especificaciones están sujetas a cambios debido a las necesidades del producto.

Dimensions are usually approximated to the nearest quarter inch that will correspond to its metric conversion. / Las medidas generalmente se dan de acuerdo a la conversión métrica correspondiente y con una medida aproximada.

AFRICA END TABLE 401
 mesa auxiliar áfrica 401

AF20-401

DIAM. 24" H 25 1/2"
 61 cm 65 cm

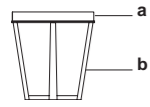

a:top finish b:base finish

AFRICA END TABLE 403
 mesa auxiliar áfrica 403

AF20-403

DIAM. 20 1/2" H 21 3/4"
 52 cm 55 cm

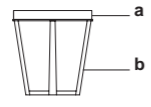

a:top finish b:base finish

Top finish / Acabado top
 Base finish / Acabado base

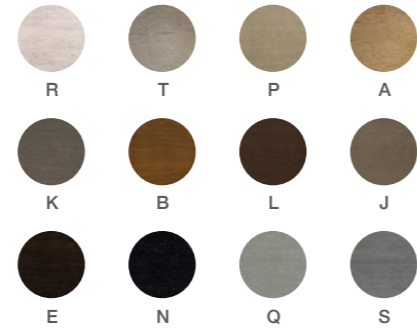

BOLERO END TABLE 100
 mesa auxiliar bolero 100

BR20-100

DIAM. 24" H 25 1/2"
 61 cm 65 cm

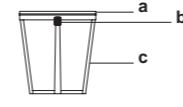

a:top finish b:decorative hardware c:base finish

BOLERO END TABLE 101 (STONE STOP)
 mesa auxiliar bolero 101 (piedra top)

BR20-101

DIAM. 24" H 25 1/2"
 61 cm 65 cm

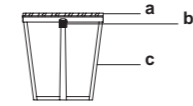

a:stone top b:decorative hardware c:base finish

Stone top / Top piedra



Top finish / Acabado top
 Base finish / Acabado base

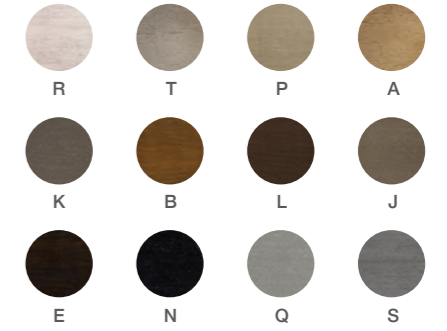

Decorative hardware / Herraje decorativo

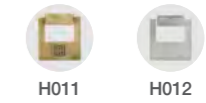

Tables sold separately. / Las mesas se venden por separado.

BOLERO END TABLE 111
(STONE TOP)
 mesa auxiliar bolero 111
 (top piedra)

BR20-111

DIAM. 19^{3/4}" H 20"
 50 cm 51 cm

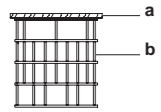

a:stone top **b:**metal finish

Stone top / Top piedra

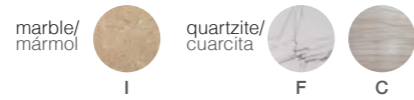

Metal finish / Acabado metal



BOLERO END TABLE 200
 mesa auxiliar bolero 200

BR20-200

w 23^{1/2}" D 23^{1/2}" H 23^{1/2}"
 60 cm 60 cm 60 cm

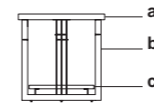

a:top finish **b:**metal finish **c:**high gloss finish

COMBINATION OPTIONS / OPCIÓN DE COMBINACIONES

Top finish / Acabado top

High gloss finish / Acabado high gloss



Metal finish / Acabado metal



BOLERO END TABLE 210
 mesa auxiliar bolero 210

BR20-210

DIAM 25^{1/4"} H 23^{1/2"}
 64 cm 60 cm

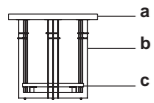

a:top finish b:metal finish c:high gloss finish

COMBINATION OPTIONS / OPCIÓN DE COMBINACIONES

Top finish / Acabado top
 High gloss finish / Acabado high gloss



Metal finish / Acabado metal



CHOCOLATE TALL NESTING TABLE 200
 mesa auxiliar alta nesting chocolate 200

CH20-200

w 19^{3/4"} D 19^{3/4"} H 25^{1/2"}
 50 cm 50 cm 65 cm

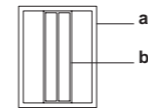
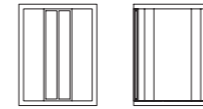

a:wood finish b:metal finish

Wood finish / Acabado madera



Metal finish / Acabado metal

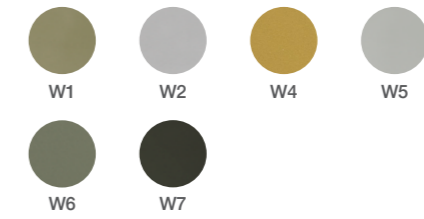

Tables sold separately. / Las mesas se venden por separado.

**CHOCOLATE LOW
NESTING TABLE 210**
mesa auxiliar baja nesting
chocolate 210

CH20-210

w 15^{3/4"} d 15^{3/4"} h 22^{3/4"}
40 cm 40 cm 58 cm

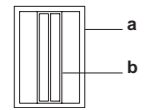
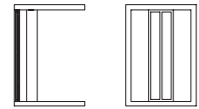

a:wood finish b:metal finish

Wood finish / Acabado madera



Metal finish / Acabado metal



Tables sold separately. / Las mesas se venden por separado.

**GEM END TABLE 101
(STONE TOP)**
mesa auxiliar gem 101
(top piedra)

GM20-101

w 19^{3/4"} d 19^{3/4"} h 23^{1/2"}
50 cm 50 cm 60 cm

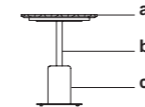
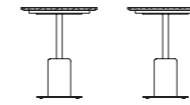

a:stone top b:metal finish c:base finish

Stone top / Top piedra

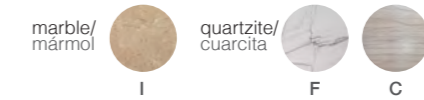

Metal finish / Acabado metal



Base finish / Acabado base

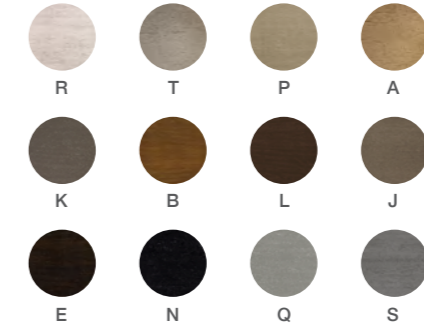



Referential photo. Some products, finishes or fabrics may no longer be available. /
Foto referencial. Algunos productos, acabados o telas podrían ya no estar disponibles.

LIVING ROOM | SALA

 ADRIANA HOYOS

GEM END TABLE 201
(STONE TOP)
 mesa auxiliar gem 201
 (top piedra)

GM20-201

H 21^{3/4"} DIAM 19^{3/4"}
 55 cm 50 cm

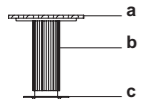
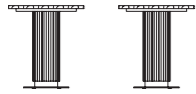

a:stone top b:base finish c:metal finish

Stone top / Top piedra



Metal finish / Acabado metal



Base finish / Acabado base



GEM NESTING SIDE TABLE 300
 mesa auxiliar nesting gem 300

GM20-300

w 13" D 19^{3/4"} H 20^{1/2"}
 33 cm 50 cm 52 cm

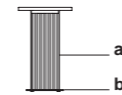
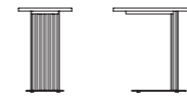

a:wood finish b:metal finish

Wood finish / Acabado madera



Metal finish / Acabado metal

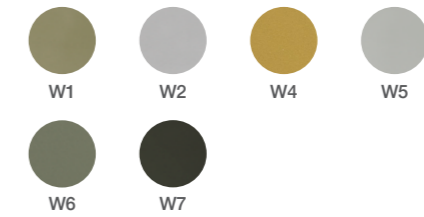

Maximum weight 3 kg (laptop). / Peso máximo 3 kg (laptop).



Referential photo. Some products, finishes or fabrics may no longer be available. /
Foto referencial. Algunos productos, acabados o telas podrían ya no estar disponibles.

LOW BISTRO TABLE 401
(STONE TOP)
 mesa baja bistro gem 401
 (top piedra)

GM20-401

DIAM 31^{1/2"} H 26^{3/4"}
 80 cm 68 cm

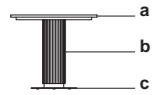

a:stone top **b:**base finish **c:**metal finish

Stone top / Top piedra



Base finish / Acabado base

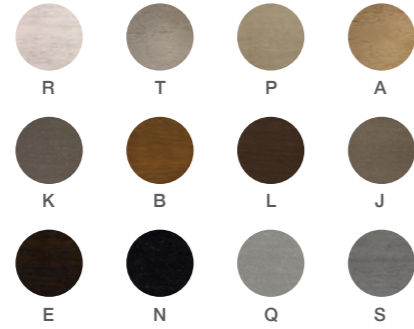

Metal finish / Acabado metal



GALAPAGOS END TABLE
100 (GLASS TOP)
 mesa auxiliar galápagos
 100 (top vidrio)

GS20-100

DIAM 23^{1/2"} H 25^{1/2"}
 60 cm 65 cm

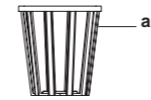

a:wood finish

Wood finish / Acabado madera



Glass top included / Incluye top de vidrio



Referential photo. Some products, finishes or fabrics may no longer be available. /
Foto referencial. Algunos productos, acabados o telas podrían ya no estar disponibles.

LIVING ROOM | SALA

 ADRIANA HOYOS

GALAPAGOS
END TABLE 200
 mesa auxiliar
 galápagos 200

GS20-200

w 19^{3/4}" d 19^{3/4}" h 25^{1/2}"
 50 cm 50 cm 65 cm

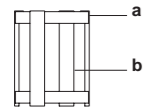
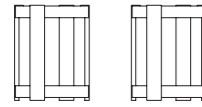

a: wood finish b: wooden detail

Wood finish / Acabado madera
 Wooden detail / Detalle madera



Referential photo. Some products, finishes or fabrics may no longer be available. /
 Foto referencial. Algunos productos, acabados o telas podrían ya no estar disponibles.

GALAPAGOS
END TABLE 300
 mesa auxiliar galápagos 300

GS20-300

w 17^{3/4"} d 17^{3/4"} h 21^{3/4"}
 45 cm 45 cm 55 cm

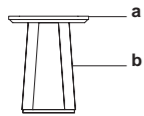
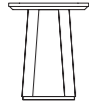

a: top finish b: base finish

Top finish / Acabado top
 Base finish / Acabado base

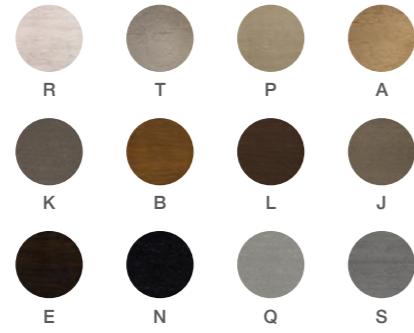

Referential photo. Some products, finishes or fabrics may no longer be available. /
 Foto referencial. Algunos productos, acabados o telas podrían ya no estar disponibles.

**GALAPAGOS END TABLE 301
(STONE TOP)**
 mesa auxiliar galápagos 301
 (top piedra)

GS20-301

w 17^{3/4}" d 17^{3/4}" h 21^{3/4}"
 45 cm 45 cm 55 cm

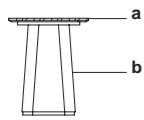
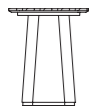

a:stone top **b:**base finish

Stone top / Top piedra



Base finish / Acabado base

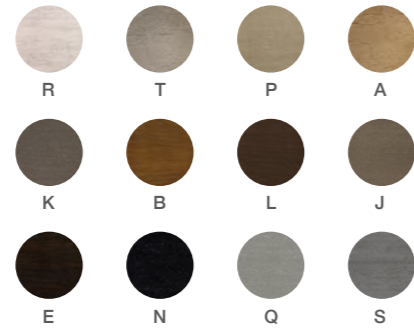

Referential photo. Some products, finishes or fabrics may no longer be available. /
 Foto referencial. Algunos productos, acabados o telas podrían ya no estar disponibles.

**GALAPAGOS
END TABLE 310**

mesa auxiliar galápagos 310

GS20-310

w 19^{3/4}" d 19^{3/4}" H 24^{1/2}"
50 cm 50 cm 62 cm

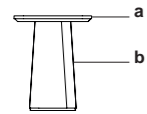
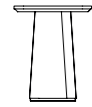

a:top finish **b**:base finish

Top finish / Acabado top
Base finish / Acabado base



**GALAPAGOS END TABLE 311
(STONE STOP)**

mesa auxiliar galápagos 311
(top piedra)

GS20-311

w 19^{3/4}" d 19^{3/4}" H 24^{1/2}"
50 cm 50 cm 62 cm

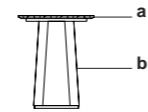

a:stone top **b**:base finish

Stone top / Top piedra

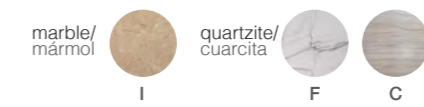

Base finish / Acabado base

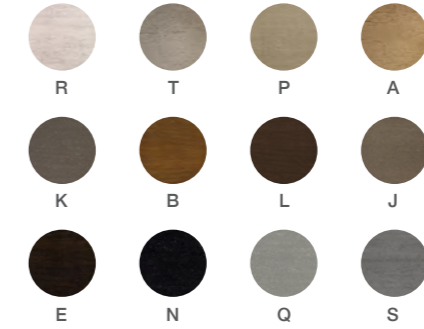

Tables sold separately. / Las mesas se venden por separado.

Tables sold separately. / Las mesas se venden por separado.



Referential photo. Some products, finishes or fabrics may no longer be available. /
Foto referencial. Algunos productos, acabados o telas podrían ya no estar disponibles.

GALAPAGOS END TABLE 750
 mesa auxiliar galápagos 750

GS20-750

w 43^{1/4"} D 11^{3/4"} H 21^{3/4"}
 110 cm 30 cm 55 cm

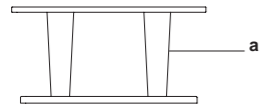
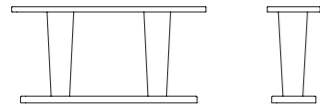

a: wood finish

Wood finish / Acabado madera

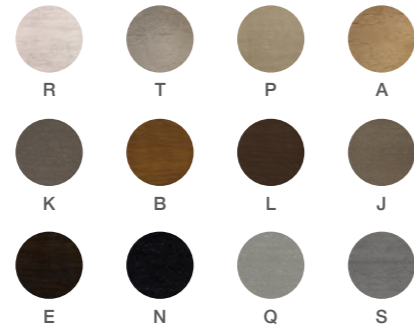

Referential photo. Some products, finishes or fabrics may no longer be available. /
 Foto referencial. Algunos productos, acabados o telas podrían ya no estar disponibles.

RUMBA END TABLE 100
 mesa auxiliar rumba 100

RM20-100

w 19^{3/4}" D 19^{3/4}" H 21^{3/4}"
 50 cm 50 cm 55 cm

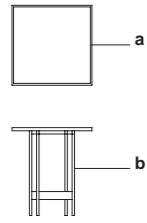
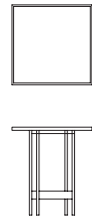

a:top finish **b:**metal finish

Top finish / Acabado top



Metal finish / Acabado metal



RUMBA END TABLE 101
(STONE TOP)
 mesa auxiliar rumba 101
 (top piedra)

RM20-101

w 19^{3/4}" D 19^{3/4}" H 21^{3/4}"
 50 cm 50 cm 55 cm

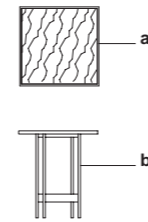

a:stone top **b:**metal finish

Stone top / Top piedra



Metal finish / Acabado metal





Referential photo. Some products, finishes or fabrics may no longer be available. /
Foto referencial. Algunos productos, acabados o telas podrían ya no estar disponibles.

RUMBA END TABLE 110
 mesa auxiliar rumba 110

RM20-110

DIAM 19^{3/4"} H 22^{3/4"}
 50 cm 58 cm

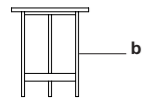
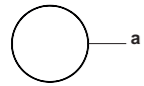
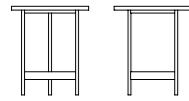

a:top finish b:metal finish

Top finish / Acabado top



Metal finish / Acabado metal



CONSOLES
 consolas



BOLERO CONSOLE 100
 consola bolero 100



CHOCOLATE CONSOLE 120
 consola chocolate 120



CARMELO CONSOLE 700
 consola caramelo 700



CARMELO CONSOLE 701
 consola caramelo 701



GEM CONSOLE 101
 consola gem 101



GALAPAGOS CONSOLE 100
 consola galapagos 100



GALAPAGOS CONSOLE 101
 consola galapagos 101



GALAPAGOS CONSOLE 200
 consola galapagos 200



GALAPAGOS CONSOLE 201
 consola galapagos 201



H CONSOLE 110
 consola h 110



TEN CONSOLE 101
 consola ten 101

Slight color variations may occur while printing tear sheets due to printers pixelation and quality. Product specifications are subject to change due to product development updates. / Ligeras variaciones de color pueden ocurrir en la impresión. Las especificaciones están sujetas a cambios debido a las necesidades del producto.

Dimensions are usually approximated to the nearest quarter inch that will correspond to its metric conversion. / Las medidas generalmente se dan de acuerdo a la conversión métrica correspondiente y con una medida aproximada.

BOLERO CONSOLE 100
(GLASS TOP)
 consola bolero 100
 (top vidrio)

BR34-100

w 63" D 19 3/4" H 33 3/4"
 160 cm 50 cm 86 cm

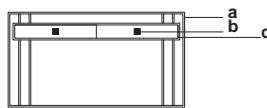
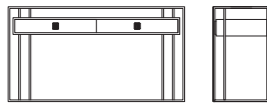

a:metal finish b:pull c:base finish

Metal finish / Acabado metal



Pull / Tiradera

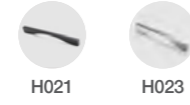
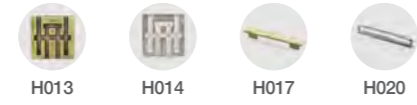

Base finish / Acabado base

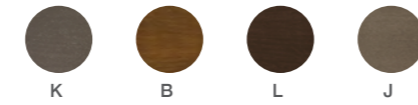

CHOCOLATE CONSOLE 120
 consola chocolate 120

CH34-120

w 78 3/4" D 15 3/4" H 25 1/4"
 200 cm 40 cm 64 cm

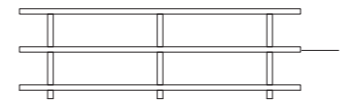
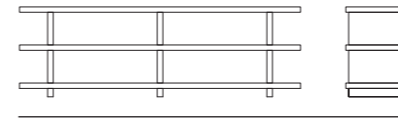

a:wood finish

Wood finish / Acabado madera

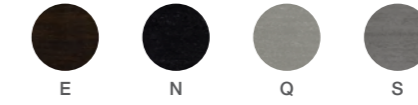

Glass top included / Incluye top de vidrio

LIVING ROOM | SALA



LIVING ROOM | SALA

CARAMELO CONSOLE 700
consola caramelo 700

CM34-700

w 70^{3/4"} D 23^{1/2"} H 33^{1/2"}
180 cm 60 cm 85 cm

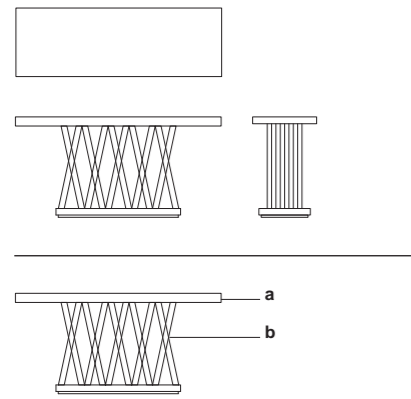

a:top finish **b:**base finish

Top finish / Acabado top
Base finish / Acabado base

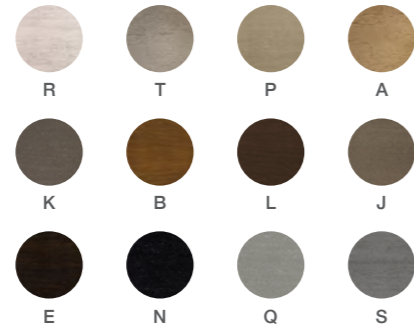

CARAMELO CONSOLE 701
(STONE STOP)
consola caramelo 701
(top piedra)

CM34-701

w 70^{3/4"} D 23^{1/2"} H 34^{1/4"}
180 cm 60 cm 87 cm

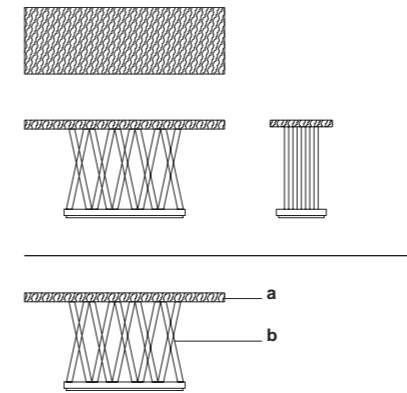

a:stone top **b:**wood finish

Stone top / Top piedra

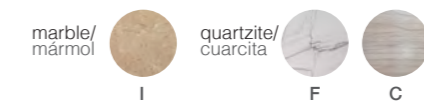

Base finish / Acabado base

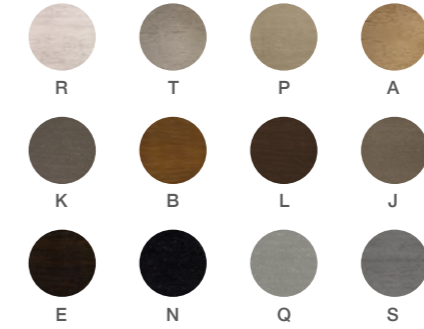

GEM CONSOLE 101
(STONE TOP)
 consola gem 101
 (top piedra)

GM34-101

w 61¹/₂" D 19³/₄" H 33³/₄"
 156 cm 50 cm 86 cm

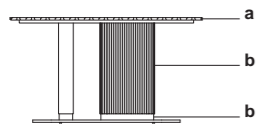
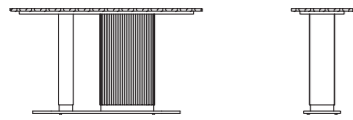
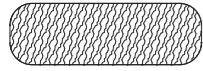

a:stone top b:base finish c:wooden detail

Stone top / Top piedra



Base finish / Acabado base

Wooden detail / Detalle madera

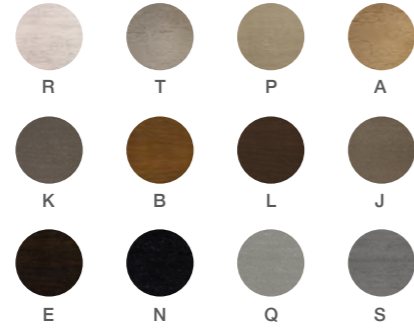

GALAPAGOS
CONSOLE 100
 consola galápagos 100

GS34-100

w 63" D 21³/₄" H 33¹/₂"
 160 cm 55 cm 85 cm

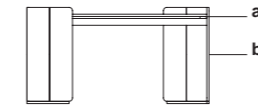
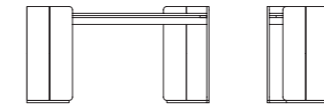
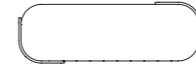

a:top finish b:base finish

Top finish / Acabado top
 Base finish / Acabado base

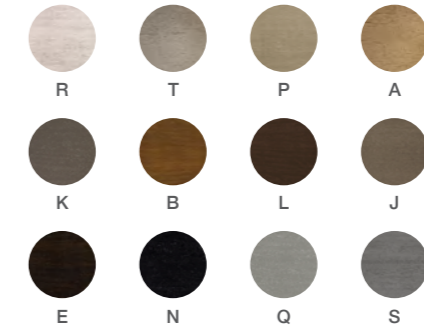

**GALAPAGOS CONSOLE 101
(STONE STOP)**
consola galápagos 101
(top piedra)

GS34-101

w 63" D 21^{3/4}" H 33^{1/2}"
160 cm 55 cm 85 cm

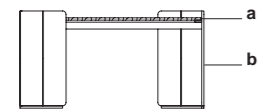
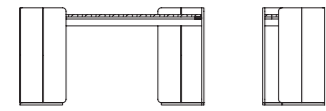
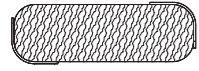

a:stone top b:base finish

Stone top / Top piedra



Base finish / Acabado base

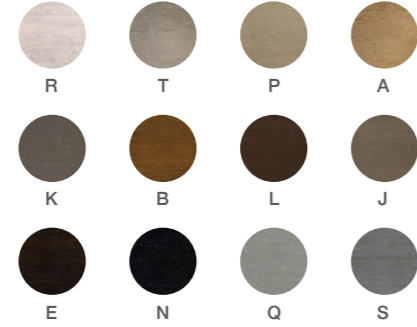

Referential photo. Some products, finishes or fabrics may no longer be available. /
Foto referencial. Algunos productos, acabados o telas podrían ya no estar disponibles.

GALAPAGOS CONSOLE 200
consola galápagos 200

GS34-200

w 67" D 19 3/4" H 33 3/4"
170 cm 50 cm 86 cm

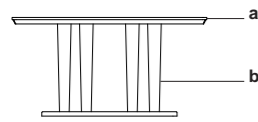
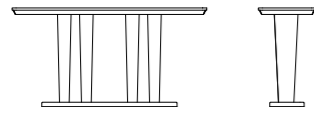

a:top finish **b:**base finish

Top finish / Acabado top
Base finish / Acabado base

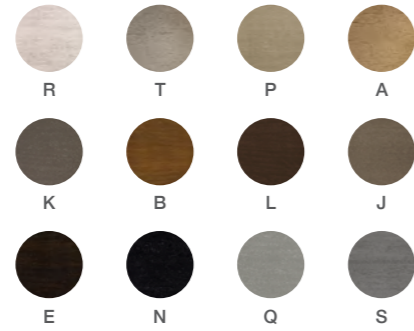

GALAPAGOS CONSOLE 201 (STONE TOP)
consola galápagos 201
(top piedra)

GS34-201

w 67" D 19 3/4" H 33 3/4"
170 cm 50 cm 86 cm

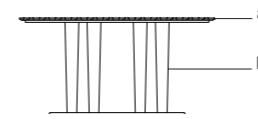
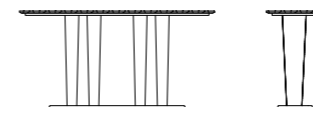
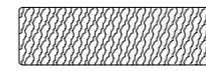

a:stone top **b:**wood finish

Stone top / Top piedra



Base finish / Acabado base

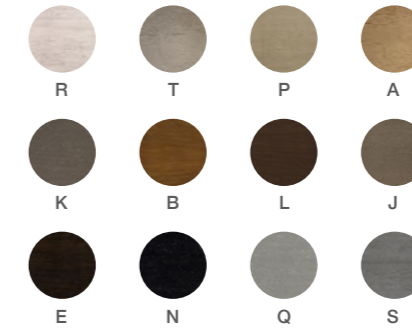



Referential photo. Some products, finishes or fabrics may no longer be available. /
Foto referencial. Algunos productos, acabados o telas podrían ya no estar disponibles.

H CONSOLE 110
consola H 110

HS34-110

w 51^{1/4"} d 13^{3/4"} h 32^{1/4"}
130 cm 35 cm 82 cm

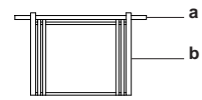
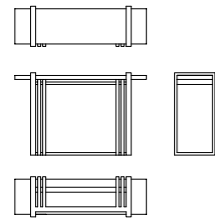

a:top finish b:base finish

Top finish / Acabado top
Base finish / Acabado base



TEN CONSOLE 101
(STONE TOP)
consola ten 101 (top piedra)

TN34-101

w 55" d 18" h 33^{1/2"}
140 cm 46 cm 85 cm

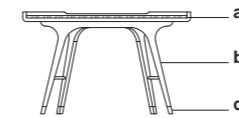
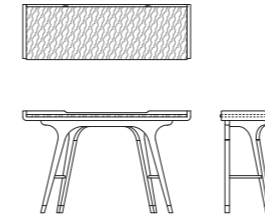

a:stone top b:wood finish c:metal finish

Stone top / Top piedra

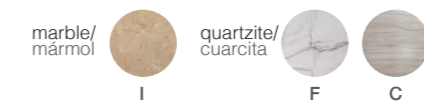

Metal finish / Acabado metal



Base finish / Acabado base

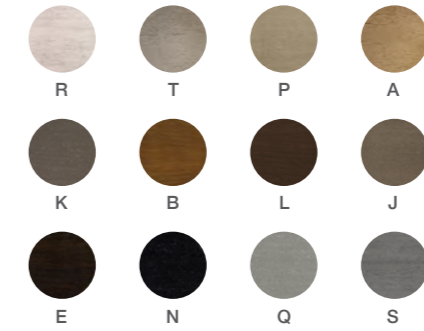

DINING ROOM | COMEDOR



DINING TABLES

mesas de comedor



CAFE DINING TABLE 401
mesa comedor café 401



CAFE DINING TABLE 431
mesa comedor café 431



CAFE DINING TABLE 451
mesa de comedor café 451



GEM DINING TABLE 100
mesa de comedor gem 100



GEM DINING TABLE 301
mesa de comedor gem 301



GEM DINING TABLE 101
mesa de comedor gem 101



GEM DINING TABLE 110
mesa de comedor gem 110



GEM DINING TABLE 111
mesa de comedor gem 111



GALAPAGOS DINING TABLE 101
mesa de comedor galápagos 101



GALAPAGOS DINING TABLE 200
mesa de comedor galápagos 200



GALAPAGOS DINING TABLE 201
mesa de comedor galápagos 201



GALAPAGOS DINING TABLE 501
mesa de comedor galápagos 501



H DINING TABLE 100/300
mesa de comedor h 100/300



H DINING TABLE 500
mesa de comedor h 500



H DINING TABLE 501
mesa de comedor h 501

Slight color variations may occur while printing tear sheets due to printers pixelation and quality. Product specifications are subject to change due to product development updates. / Ligeras variaciones de color pueden ocurrir en la impresión. Las especificaciones están sujetas a cambios debido a las necesidades del producto.

Dimensions are usually approximated to the nearest quarter inch that will correspond to its metric conversion. / Las medidas generalmente se dan de acuerdo a la conversión métrica correspondiente y con una medida aproximada.

DINING TABLES

mesas de comedor



RUMBA DINING TABLE 100
mesa de comedor rumba 100



RUMBA DINING TABLE 101
mesa de comedor rumba 101



RUMBA DINING TABLE 110
mesa de comedor rumba 110



RUMBA DINING TABLE 210
mesa de comedor rumba 210



RUMBA DINING TABLE 300
mesa de comedor rumba 300



RUMBA DINING TABLE 400
mesa de comedor rumba 400



RUMBA DINING TABLE 401
mesa de comedor rumba 401



RUMBA DINING TABLE 501
mesa de comedor rumba 501



TEN DINING TABLE 100
mesa de comedor ten 100



TEN DINING TABLE 110/120/130
mesa de comedor ten 110/120/130

Slight color variations may occur while printing tear sheets due to printers pixelation and quality. Product specifications are subject to change due to product development updates. / Ligeras variaciones de color pueden ocurrir en la impresión. Las especificaciones están sujetas a cambios debido a las necesidades del producto.

Dimensions are usually approximated to the nearest quarter inch that will correspond to its metric conversion. / Las medidas generalmente se dan de acuerdo a la conversión métrica correspondiente y con una medida aproximada.

**CAFE DINING TABLE 401
(STONE TOP)**
 mesa de comedor café
 401(top piedra)

CF04-401

w 94^{1/2}" D 51^{1/4}" H 30"
 240 cm 130 cm 76 cm

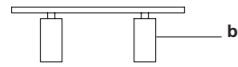
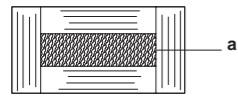
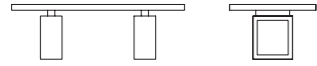
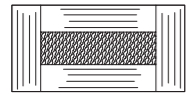

a:stone top b:wood finish

Stone top / Top piedra



Wood finish / Acabado madera



**CAFE DINING TABLE 431
(STONE TOP)**
 mesa comedor café 431
 (top piedra)

CF04-431

w 94^{1/2}" D 47^{1/4}" H 30"
 240 cm 120 cm 76 cm

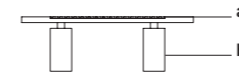
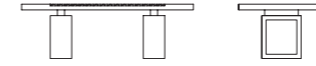
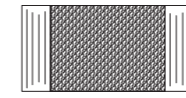

a:stone top b:wood finish

Stone top / Top piedra



Wood finish / Acabado madera

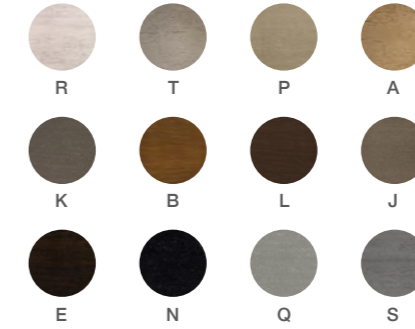

CAFE DINING TABLE 451
(STONE TOP)
 mesa de comedor café
 451(top piedra)

CF04-451

w 78^{3/4"} D 43^{1/2"} H 30"
 200 cm 110 cm 76 cm

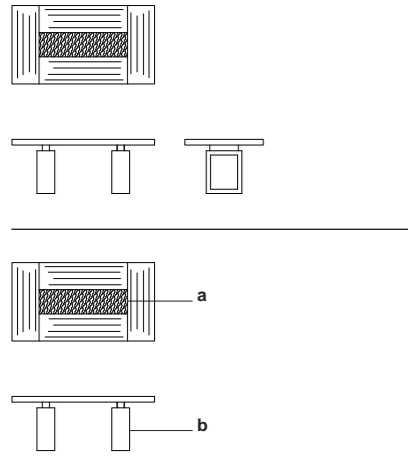

a:stone top b:wood finish

Stone top / Top piedra



Wood finish / Acabado madera



GEM DINING TABLE 100
 mesa de comedor gem 100

GM04-100

w 94^{1/2"} D 45^{1/4"} H 30"
 240 cm 115 cm 76 cm

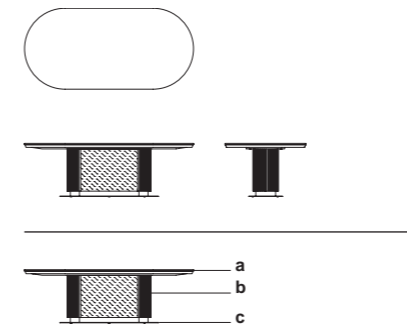

a:top finish b:base finish c:metal finish

Top finish / Acabado top
 Base finish / Acabado base



Metal finish / Acabado metal

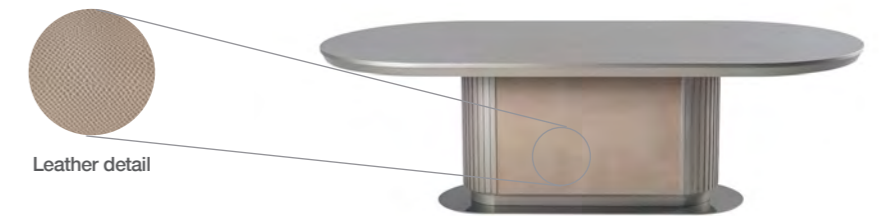
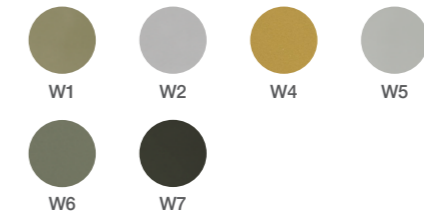

GEM DINING TABLE 101

(STONE TOP)

mesa de comedor gem 101
(top piedra)

GM04-101

w 94^{1/2}" D 45^{1/4}" H 30"
240 cm 115 cm 76 cm

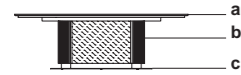
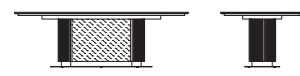
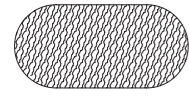

a:stone top b:base finish c:metal finish

Stone top / Top piedra

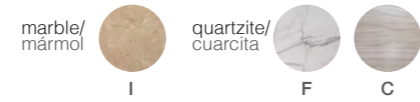

Base finish / Acabado base



Metal finish / Acabado metal

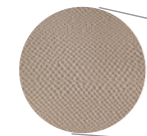

Leather detail



Referential photo. Some products, finishes or fabrics may no longer be available. /
Fotó referencial. Algunos productos, acabados o telas podrían ya no estar disponibles.

GEM DINING TABLE 110
 mesa de comedor gem 110

GM04-110

w 94^{1/2}" D 45^{1/4}" H 30"
 240 cm 115 cm 76 cm

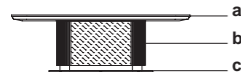
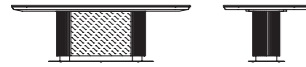

a:top finish b:base finish c:metal finish

Top finish / Acabado top
 Base finish / Acabado base

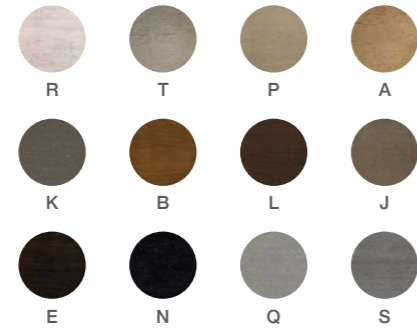

Metal finish / Acabado metal

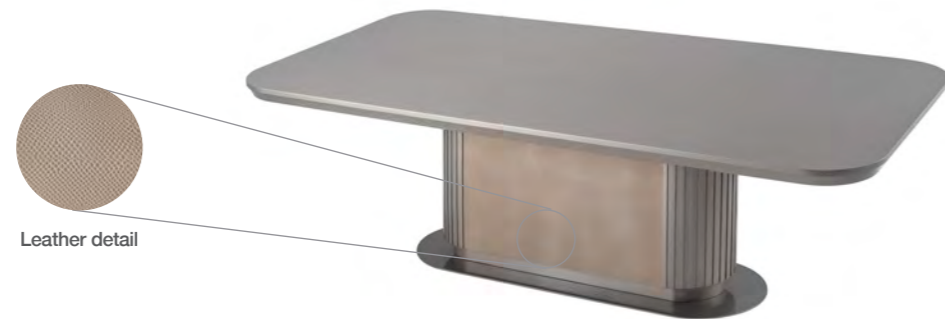

Leather detail



GEM DINING TABLE 111
 (STONE TOP)
 mesa de comedor gem 111
 (top piedra)

GM04-111

w 94^{1/2}" D 45^{1/4}" H 30"
 240 cm 115 cm 76 cm

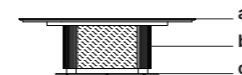
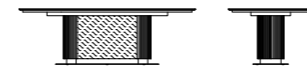
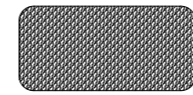

a:stone top b:base finish c:metal finish

Stone top / Top piedra

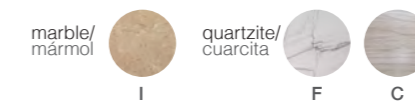

Base finish / Acabado base

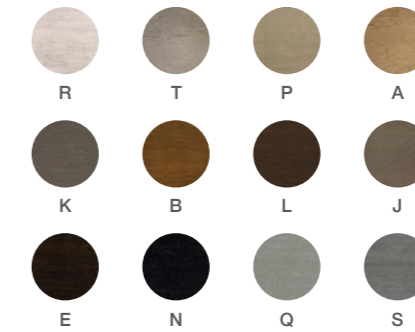

Metal finish / Acabado metal

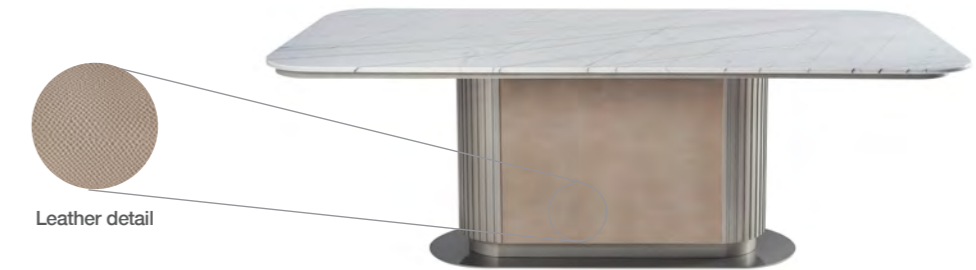
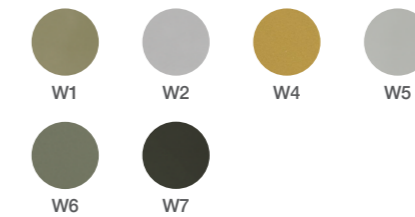

Leather detail

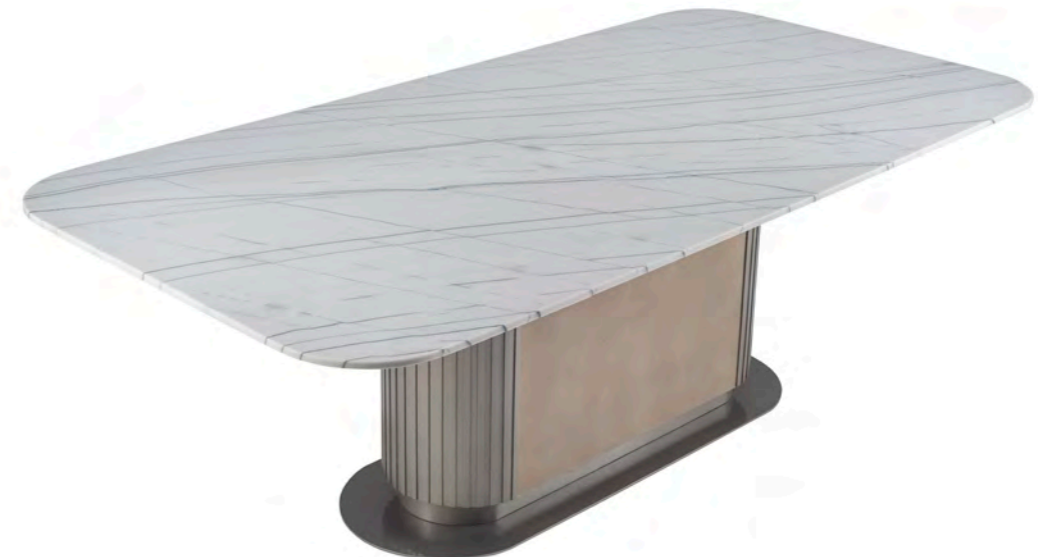

GEM DINING TABLE 301
(STONE TOP)
 mesa de comedor gem
 301 (top piedra)

GM04-301

DIAM 51^{1/4}" H 30"
 130 cm 76 cm

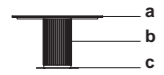
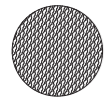

a:stone top b:base finish c:metal finish

Stone top / Top piedra



Base finish / Acabado base

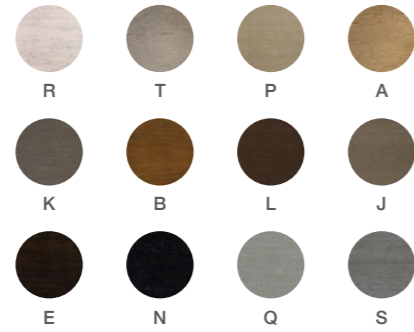

Metal finish / Acabado metal



GALAPAGOS DINING TABLE
101 (STONE TOP)
 mesa de comedor
 galápagos 101 (top piedra)

GS04-101

w 90^{1/2}" D 51^{1/4}" H 30"
 230 cm 130 cm 76 cm

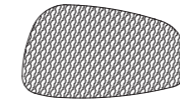

a:stone top b:base finish

Stone top / Top piedra



Base finish / Acabado base

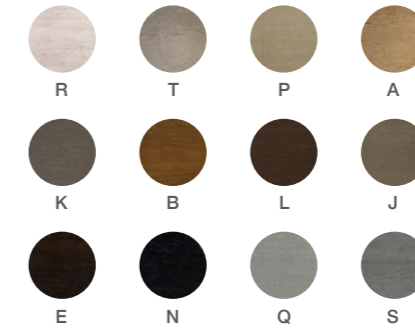



Referential photo. Some products, finishes or fabrics may no longer be available. /
Foto referencial. Algunos productos, acabados o telas podrían ya no estar disponibles.

**GALAPAGOS DINING
TABLE 200**
mesa de comedor
galápagos 200

GS04-200

w 94^{1/2"} D 47^{1/4"} H 30"
240 cm 120 cm 76 cm

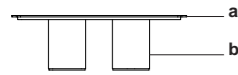
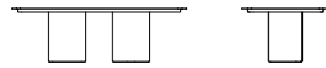
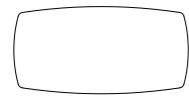

a: top finish **b:** base finish

Top finish / Acabado top
Base finish / Acabado base

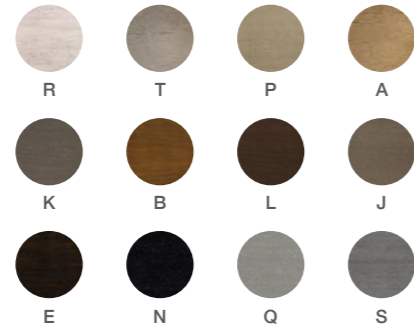

**GALAPAGOS DINING
TABLE 201 (STONE TOP)**
mesa de comedor
galápagos 201 (top piedra)

GS04-201

w 94^{1/2"} D 47^{1/4"} H 30"
240 cm 120 cm 76 cm

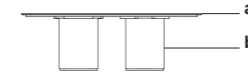
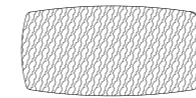

a: stone top **b:** base finish

Stone top / Top piedra

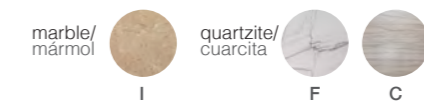

Base finish / Acabado base

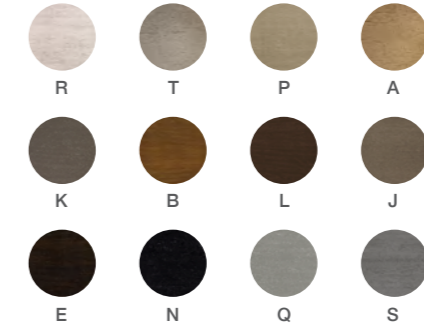



Referential photo. Some products, finishes or fabrics may no longer be available. /
Fotó referencial. Algunos productos, acabados o telas podrían ya no estar disponibles.

GALAPAGOS DINING TABLE (STONE TOP)
 mesa de comedor galápagos (top piedra)

GS04-501

W 118" D 51 1/4" H 30"
 300 cm 130 cm 76 cm

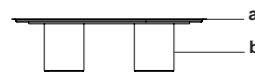
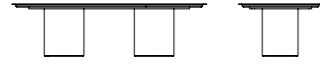
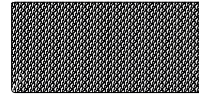

a:dekon top b:base finish

Dekton top / Top dekon

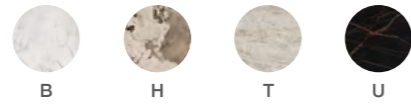

Base finish / Acabado base

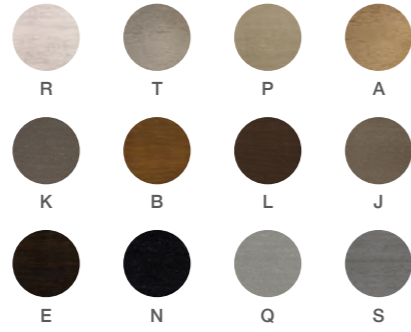

Special Lead Time: please confirm this product lead time before placing any order /
 Plazo de entrega especial: confirme el tiempo de entrega de este producto antes de realizar cualquier pedido.



Referential photo. Some products, finishes or fabrics may no longer be available. /
 Foto referencial. Algunos productos, acabados o telas podrían ya no estar disponibles.

**H DINING TABLE 300
(GLASS TOP)**
mesa de comedor h 300
(top vidrio)

HS04-300*

DIAM. 51^{1/4}" H 30"
130 cm 76 cm

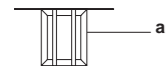
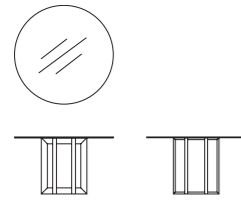

a: wood finish

*SKU valid only for Ecuador
*SKU válido únicamente para Ecuador

**H DINING TABLE
BASE 100**
base mesa de
comedor h 100

HS06-100

W 23^{1/2}" D 23^{1/2}" H 29^{1/4}"
60 cm 60 cm 74 cm

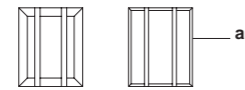
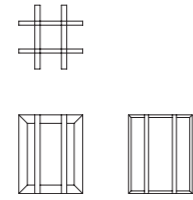

a: wood finish

Top glass / top vidrio

VN004

DIAM. 51^{1/4}" H 1^{1/2}"
130 cm 1 cm



Wood finish / Acabado madera



H DINING TABLE 500
mesa de comedor h 500

HS04-500

W 82^{3/4}" D 43^{1/4}" H 30"
210 cm 110 cm 76 cm

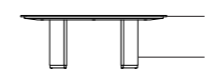
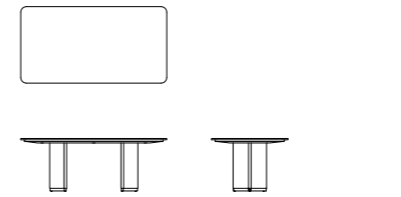

a: top finish b: base finish

Top finish / Acabado top
Base finish / Acabado base

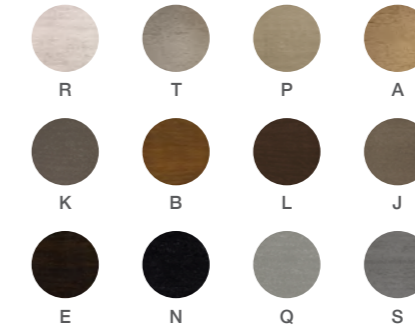

**H DINING TABLE 501
(PORCELAIN TOP)**
mesa de comedor h 501
(top porcelanato)

HS04-501

w 82^{3/4"} D 43^{1/4"} H 30"
210 cm 110 cm 76 cm

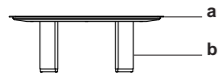
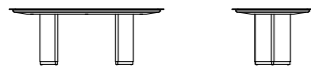
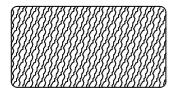

a:porcelain top **b:**base finish

Porcelain top / Top porcelanato*

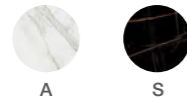

Base finish / Acabado base

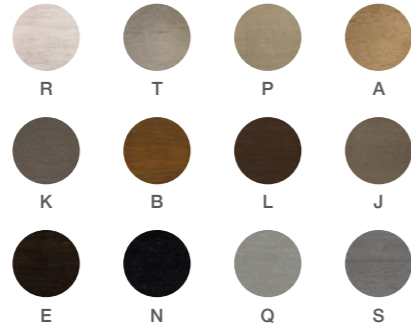

**RUMBA DINING
TABLE 100**
mesa de comedor
rumba 100

RM04-100

w 94^{1/2"} D 47^{1/4"} H 30"
240 cm 120 cm 76 cm

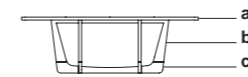
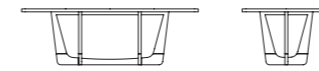

a:top finish **b:**base finish **c:**wooden detail

Top finish / Acabado top
Base finish / Acabado base
Wooden detail / Detalle madera

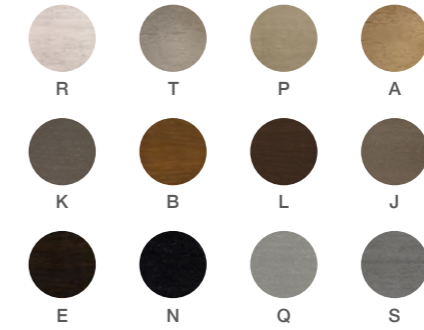

*Only available on specific H Collection products. / Disponible únicamente para productos específicos de la Colección H.



Referential photo. Some products, finishes or fabrics may no longer be available. /
Foto referencial. Algunos productos, acabados o telas podrían ya no estar disponibles.

RUMBA
DINING TABLE 101
(STONE TOP)
 mesa de comedor rumba
 101 (top piedra)

RM04-101

w 94¹/₂" D 47¹/₄" H 30"
 240 cm 120 cm 76 cm

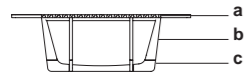
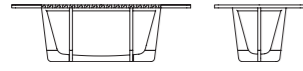
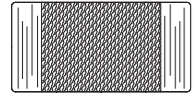

a:stone top b:base finish c:wooden detail

Stone top / Top piedra



Base finish / Acabado base
 Wooden detail / Detalle madera

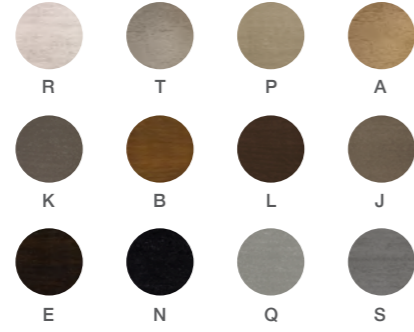

Referential photo. Some products, finishes or fabrics may no longer be available. /
 Foto referencial. Algunos productos, acabados o telas podrían ya no estar disponibles.

**RUMBA DINING
TABLE 110 (GLASS TOP)**
mesa de comedor
rumba 110 (top vidrio)

RM04-110*

w 94^{1/2}" D 51^{1/4}" H 30"
240 cm 130 cm 76 cm

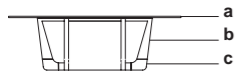
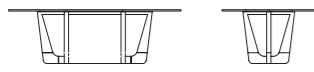

a:metallic button b:base finish c:wooden detail

*SKU valid only for Ecuador
*SKU válido únicamente para Ecuador

**RUMBA DINING TABLE
110 BASE**
base mesa de comedor
rumba 110

RM06-110

w 63" D 28^{1/4}" H 29^{1/4}"
160 cm 72 cm 74 cm

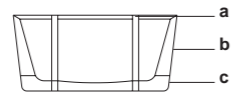
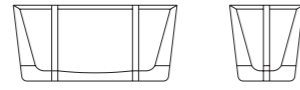
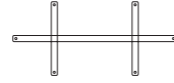

a:metallic button b:base finish c:wooden detail

Glass top / Top vidrio

VN232

w 94^{1/2}" D 51^{1/4}" H 3/4"
240 cm 130 cm 1,9 cm



Base finish / Acabado base
Wooden detail / Detalle madera

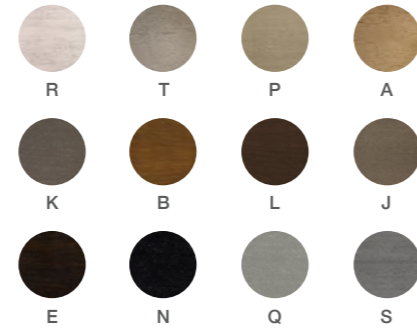

Metallic button / Botón metálico

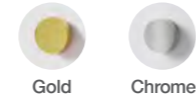

Metallic button

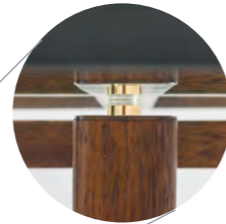

Referential photo. Some products, finishes or fabrics may no longer be available. /
Foto referencial. Algunos productos, acabados o telas podrían ya no estar disponibles.

RUMBA DINING TABLE 210 (GLASS TOP)
 mesa de comedor rumba 210 (top vidrio)

RM04-210*

DIAM. 59" H 30"
 150 cm 76 cm

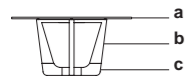
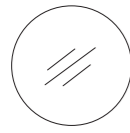

a:metallic button b:base finish c:wooden detail

*SKU valid only for Ecuador
 *SKU válido únicamente para Ecuador

RUMBA DINING TABLE 210 BASE
 base mesa de comedor rumba 210

RM06-210

w 34^{3/4}" D 34^{3/4}" H 29^{1/4}"
 88 cm 88 cm 74 cm

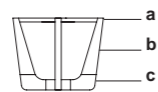
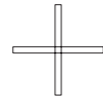

a:metallic button b:base finish c:wooden detail

Glass top / top vidrio

VN093

DIAM 59" H 3/4"
 150 cm 1,9 cm

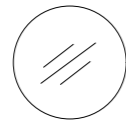

Base finish / Acabado base
 Wooden detail / Detalle madera



Metallic button / Botón metálico

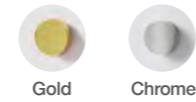

RUMBA DINING TABLE 300
 mesa de comedor rumba 300

RM04-300

w 94^{1/2}" D 51^{1/4}" H 30"
 240 cm 130 cm 76 cm

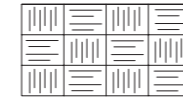

a:top finish b:base finish

Top finish / Acabado top
 Base finish / Acabado base

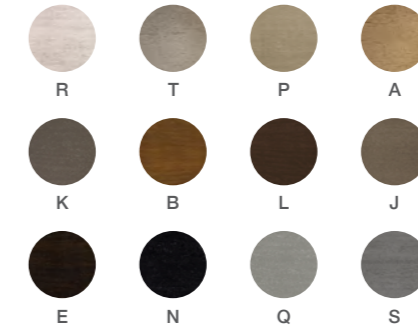



Referential photo. Some products, finishes or fabrics may no longer be available. /
Foto referencial. Algunos productos, acabados o telas podrían ya no estar disponibles.

**RUMBA DINING
TABLE 400**
mesa de comedor
rumba 400

RM04-400

w 94^{1/2}" D 47^{1/4}" H 30"
240 cm 120 cm 76 cm

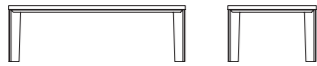
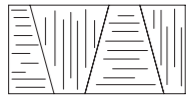

a: wood finish

Wood finish / Acabado madera

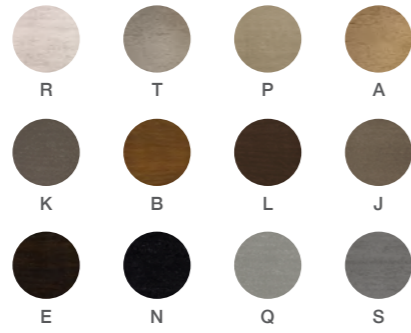

Referential photo. Some products, finishes or fabrics may no longer be available. /
Foto referencial. Algunos productos, acabados o telas podrían ya no estar disponibles.

RUMBA DINING TABLE 401 (STONE TOP)

mesa de comedor rumba 401 (top piedra)

RM04-401

w 110^{1/4"} D 51^{1/4"} H 30"
280 cm 130 cm 76 cm

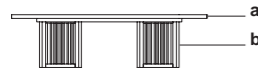
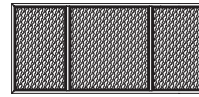

a:stone top **b:**base finish

Stone top / Top piedra



Base finish / Acabado base

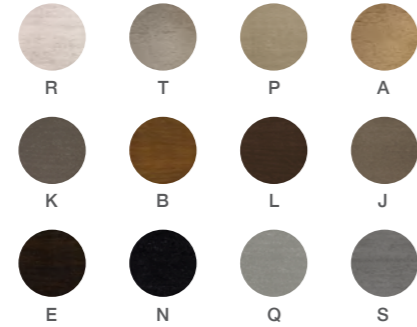

RUMBA DINING TABLE 501 (STONE TOP)

mesa de comedor rumba 501 (top piedra)

RM04-501

w 118" D 51^{1/4"} H 30"
300 cm 130 cm 76 cm

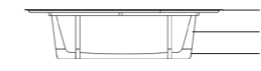
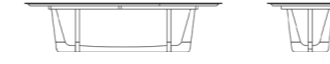
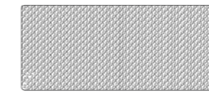

a:dekton top **b:**base finish **c:**wooden detail

Dekton top / Top dekon

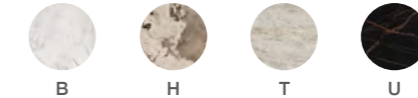

Base finish / Acabado base
Wooden detail / Detalle madera

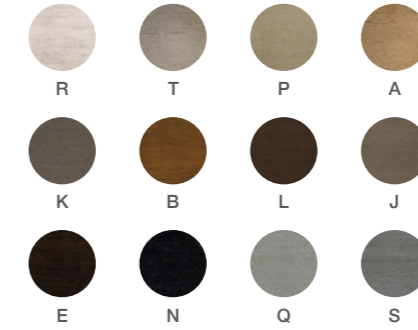

Special Lead Time: please confirm this product lead time before placing any order /
Plazo de entrega especial: confirme el tiempo de entrega de este producto antes de realizar cualquier pedido.



Referential photo. Some products, finishes or fabrics may no longer be available. /
Foto referencial. Algunos productos, acabados o telas podrían ya no estar disponibles.

**TEN DINING TABLE 100
(GLASS TOP)**
mesa de comedor ten 100
(top vidrio)

TN04-100*

DIAM. 59" H 30"
150 cm 76 cm

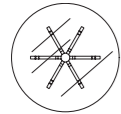

a: wood finish
*SKU valid only for Ecuador
*SKU válido únicamente para Ecuador

**TEN DINING TABLE
BASE 100**
base mesa de
comedor ten 100

TN06-100

W 38^{1/4"} D 38^{1/4"} H 29^{1/4"}
97 cm 97 cm 74 cm

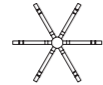

a: wood finish

Glass top / Top vidrio

VN093

DIAM. 59" H 3^{3/4"}
150 cm 1,9 cm



Wood finish / Acabado madera



**TEN DINING TABLE 120
(GLASS TOP)**
mesa de comedor ten
120 (top vidrio)

TN04-120*

W 82^{3/4"} D 47^{1/4"} H 30"
210 cm 120 cm 76 cm

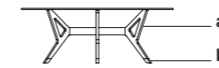
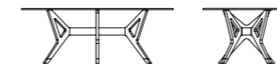
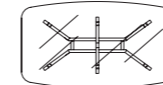

a: base finish b: metal finish
*SKU valid only for Ecuador
*SKU válido únicamente para Ecuador

**TEN DINING TABLE 130
(GLASS TOP)**
mesa de comedor ten
130 (top vidrio)

TN04-130*

W 94^{1/2"} D 47^{1/4"} H 30"
240 cm 120 cm 76 cm

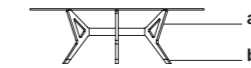
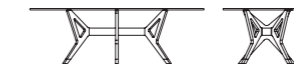
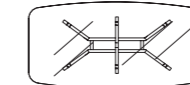

a: base finish b: metal finish
*SKU valid only for Ecuador
*SKU válido únicamente para Ecuador

Base finish / Acabado base



Metal finish / Acabado metal



**TEN DINING TABLE
BASE 110**
base mesa de comedor
ten 110

TN06-110

w 59" D 30^{3/4}" H 29^{1/4}"
150 cm 78 cm 74 cm

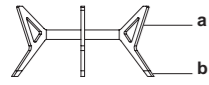
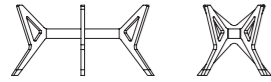
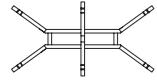

a:base finish **b:**metal finish

Glass top / Top vidrio

VN190

w 94^{1/2}" D 47^{1/4}" H 3^{3/4}"
240 cm 120 cm 1,9 cm

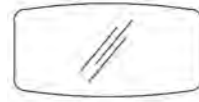

VN189

w 82^{3/4}" D 47^{1/4}" H 3^{3/4}"
210 cm 120 cm 1,9 cm

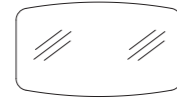

Base finish / Acabado base



Metal finish / Acabado metal



Referential photo. Some products, finishes or fabrics may no longer be available. /
Foto referencial. Algunos productos, acabados o telas podrían ya no estar disponibles.

DINING CHAIRS

sillas de comedor



BOLERO SIDE CHAIR 200
silla s/b bolero 200



BOLERO SIDE CHAIR 210
silla s/b bolero 210



CHOCOLATE SIDE CHAIR 120
silla s/b chocolate 120



H SIDE CHAIR 100
silla s/b h 100



H SIDE CHAIR 300
silla s/b h 300



H ARM CHAIR 300
silla c/b h 300



CHOCOLATE ARM CHAIR 120
silla c/b chocolate 120



CARAMELO SIDE CHAIR 740
silla s/b caramelo 740



CARAMELO SIDE CHAIR 750
silla s/b caramelo 750



RUMBA SIDE CHAIR 210
silla s/b rumba espaldar bajo 210



RUMBA SIDE CHAIR 400
silla s/b rumba 400



RUMBA SIDE CHAIR 410
silla s/b rumba 410



GEM SIDE CHAIR 100
silla s/b gem 100



GEM ARM CHAIR 100
silla c/b gem 100



GALAPAGOS CHAIR 100
silla galápagos 100



TEN CHAIR 100
silla ten 100



TEN SIDE CHAIR 110
silla s/b ten 110



GALAPAGOS SIDE CHAIR 110
silla s/b galápagos 110



GRAFITO SIDE CHAIR 200
silla s/b grafito 200



GRAFITO ARM CHAIR 200
silla c/b grafito 200

Slight color variations may occur while printing tear sheets due to printers pixelation and quality. Product specifications are subject to change due to product development updates. / Ligeras variaciones de color pueden ocurrir en la impresión. Las especificaciones están sujetas a cambios debido a las necesidades del producto.

Dimensions are usually approximated to the nearest quarter inch that will correspond to its metric conversion. / Las medidas generalmente se dan de acuerdo a la conversión métrica correspondiente y con una medida aproximada.

DINING CHAIRS

sillas de comedor

Slight color variations may occur while printing tear sheets due to printers pixelation and quality. Product specifications are subject to change due to product development updates. / Ligeras variaciones de color pueden ocurrir en la impresión. Las especificaciones están sujetas a cambios debido a las necesidades del producto.

Dimensions are usually approximated to the nearest quarter inch that will correspond to its metric conversion. / Las medidas generalmente se dan de acuerdo a la conversión métrica correspondiente y con una medida aproximada.

BOLERO SIDE CHAIR 200
silla s/b bolero 200

BR01-200

w 23^{1/4"} D 26^{1/2"} H 39^{1/4"} SH 19^{3/4"}
59 cm 67 cm 100 cm 50 cm

sw 19^{1/4"} SD 20"
49 cm 51 cm

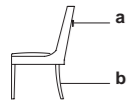
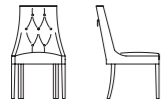

a:decorative hardware b:wood finish

Wood finish / Acabado madera



Decorative hardware / Herraje decorativo

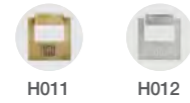

BOLERO SIDE CHAIR 210
silla s/b bolero 210

BR01-210

w 23^{1/4"} D 26^{1/2"} H 39^{1/4"} SH 19^{3/4"}
59 cm 67 cm 100 cm 50 cm

sw 19^{1/4"} SD 20"
49 cm 51 cm

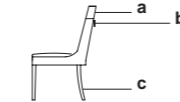

a:leather detail b:decorative hardware c:wood finish

Wood finish / Acabado madera

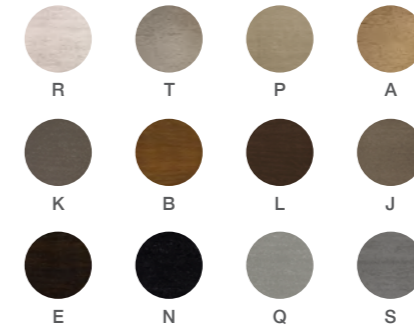

Leather detail / Detalle cuero



Decorative hardware / Herraje decorativo

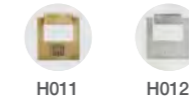

**CHOCOLATE SIDE
CHAIR 120**
silla s/b chocolate 120

CH01-120

W 21^{3/4"} D 24^{3/4"} H 39^{3/4"} SH 19^{3/4"}
55 cm 63 cm 101 cm 50 cm

SW 21^{3/4"} SD 19^{1/4"}
55 cm 49 cm

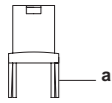
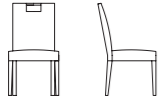

a: wood finish

Wood finish / Acabado madera

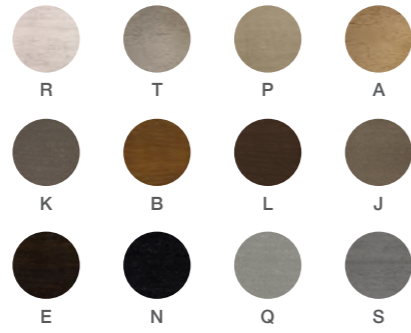

**CHOCOLATE ARM
CHAIR 120**
silla c/b chocolate 120

CH02-120

W 24" D 24^{3/4"} H 39^{3/4"} SH 19^{3/4"}
61 cm 63 cm 101 cm 50 cm

SW 21^{3/4"} SD 19^{1/4"} AH 24^{3/4"}
55 cm 49 cm 63 cm

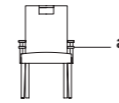
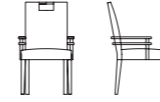

a: wood finish

Wood finish / Acabado madera

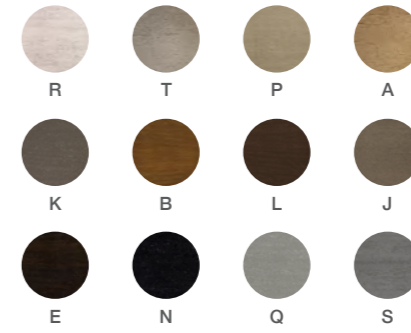

CARAMELO SIDE CHAIR 740
silla s/b caramelo 740

CM01-740

W 22^{3/4}" D 28^{3/4}" H 41^{1/4}" SH 19^{3/4}"
58 cm 73 cm 105 cm 50 cm

SW 19" SD 20"
48 cm 51 cm

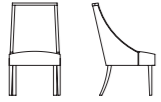

a: wood finish

Wood finish / Acabado madera



CARAMELO SIDE CHAIR 750
silla s/b caramelo 750

CM01-750

W 22^{3/4}" D 28^{3/4}" H 41^{1/4}" SH 19^{3/4}"
58 cm 73 cm 105 cm 50 cm

SW 19" SD 20"
48 cm 51 cm

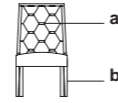
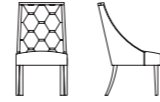

a: decorative plate b: wood finish

Wood finish / Acabado madera

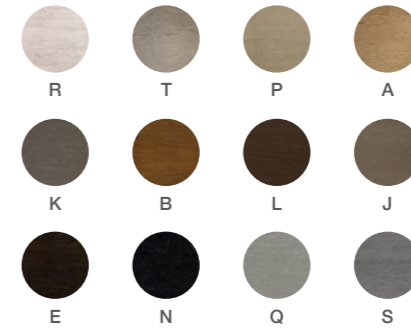

Decorative plate / Placa decorativa

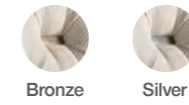

GEM SIDE CHAIR 100
silla s/b gem 100

GM01-100

w 20" D 24^{1/2"} H 34^{3/4"} SH 19^{3/4"}
51 cm 62 cm 88 cm 50 cm

sw 20" SD 19^{1/4"}
51 cm 49 cm

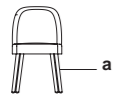

a: wood finish

Wood finish / Acabado madera



Piping detail / Detalle ribete



Piping can be customized using leather or fabric. / El ribete puede personalizarse en tela y cuero.



Referential photo. Some products, finishes or fabrics may no longer be available. / Foto referencial. Algunos productos, acabados o telas podrían ya no estar disponibles.

GEM ARM CHAIR 100
silla c/b gem 100

GM02-100

w 24^{1/2"} D 25^{1/2"} H 34^{3/4"} SH 19^{3/4"}
62 cm 65 cm 88 cm 50 cm

SW 21^{3/4"} SD 19^{3/4"} AH 26"
55 cm 50 cm 66 cm

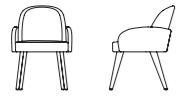

a: wood finish

Wood finish / Acabado madera

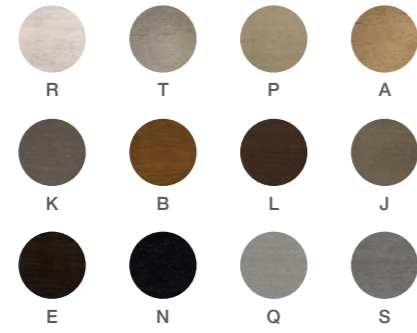

Piping detail / Detalle ribete



Piping can be customized using leather or fabric. / El ribete puede personalizarse en tela y cuero.



Referential photo. Some products, finishes or fabrics may no longer be available. / Foto referencial. Algunos productos, acabados o telas pueden ya no estar disponibles.

GALAPAGOS CHAIR 100
silla galápagos 100

GS01-100

w 23^{1/2"} D 26^{1/2"} H 34^{1/4"} SH 19^{3/4"}
60 cm 67 cm 87 cm 50 cm

SW 19^{3/4"} SD 20" AH 26"
50 cm 51 cm 66 cm



a: wood finish

Wood finish / Acabado madera

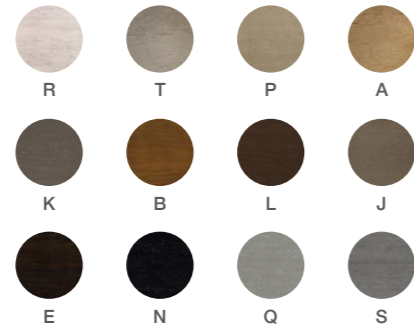

Referential photo. Some products, finishes or fabrics may no longer be available. /
Foto referencial. Algunos productos, acabados o telas podrían ya no estar disponibles.

GALAPAGOS SIDE CHAIR 110
silla s/b galápagos 110

GS01-110

w 22^{3/4"} d 26^{1/2"} h 34^{1/4"} sh 19^{3/4"}
58 cm 67 cm 87 cm 50 cm

sw 19^{3/4"} sd 20"
50 cm 51 cm



a: wood finish

Wood finish / Acabado madera



Referential photo. Some products, finishes or fabrics may no longer be available. /
Foto referencial. Algunos productos, acabados o telas podrían ya no estar disponibles.

GRAFITO SIDE CHAIR 200
silla s/b grafito 200

GT01-200

w 19^{3/4"} D 26" H 37" SH 19^{3/4"}
50 cm 66 cm 94 cm 50 cm

SW 19^{3/4"} SD 19^{3/4"}
50 cm 50 cm

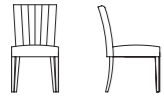

a: wood finish

Wood finish / Acabado madera

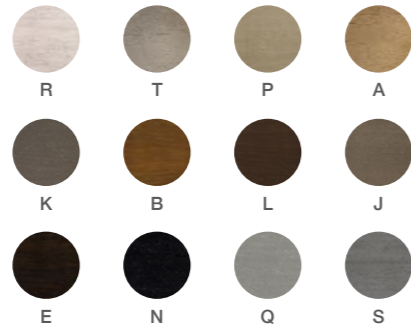

GRAFITO ARM CHAIR 200
silla c/b grafito 200

GT02-200

w 23^{1/2"} D 26" H 37" SH 19^{3/4"}
60 cm 66 cm 94 cm 50 cm

SW 19^{3/4"} SD 19^{3/4"} AH 26"
50 cm 50 cm 66 cm

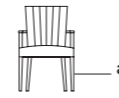
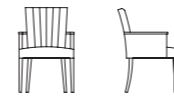

a: wood finish

Wood finish / Acabado madera

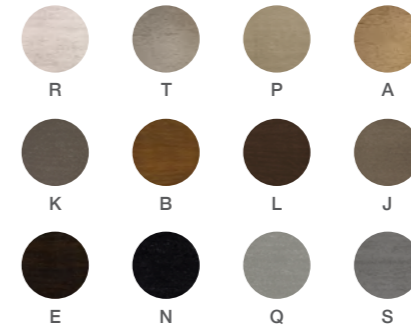

H SIDE CHAIR 100
silla s/b h 1 00

HS01-100

w 19" D 23^{1/2}" H 37^{1/2}" SH 19^{3/4}"
48 cm 60 cm 95 cm 50 cm

sw 19" sd 19"
48 cm 48 cm

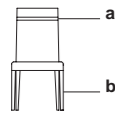
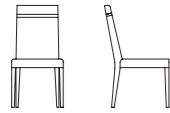

a:leather detail b:wood finish

Wood finish / Acabado madera

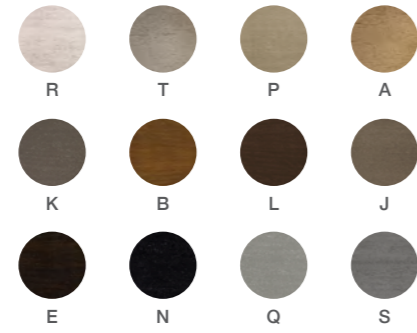

Leather detail / Detalle cuero



H SIDE CHAIR 300
silla s/b h 300

HS01-300

w 19" D 24^{3/4}" H 35^{1/2}" SH 19^{3/4}"
48 cm 63 cm 90 cm 50 cm

sw 19" sd 19"
48 cm 48 cm

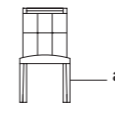
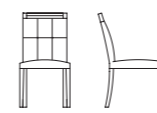

a:wood finish

Wood finish / Acabado madera

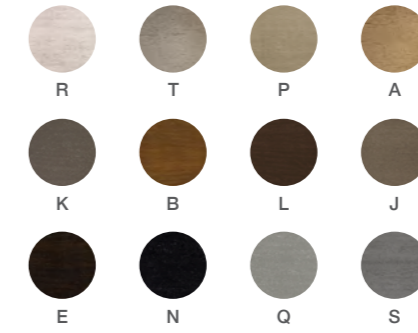

H ARM CHAIR 300
silla c/b h 300

HS02-300

w 22^{1/2"} D 24^{3/4"} H 35^{1/2"} SH 19^{3/4"}
57 cm 63 cm 90 cm 50 cm

sw 18" SD 19" AH 24^{3/4"}
46 cm 48 cm 63 cm

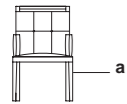
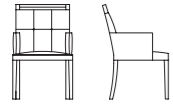

a: wood finish

Wood finish / Acabado madera

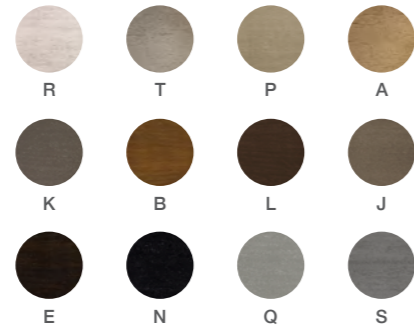

RUMBA LOW BACK SIDE CHAIR 210
silla rumba espaldar bajo 210

RM01-210

w 20^{1/2"} D 24^{1/2"} H 34^{1/4"} SH 19^{3/4"}
52 cm 62 cm 87 cm 50 cm

sw 20^{1/2"} SD 20^{1/2"}
52 cm 52 cm



a: wood finish

Wood finish / Acabado madera

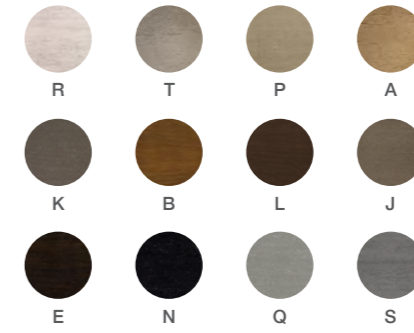



Referential photo. Some products, finishes or fabrics may no longer be available. /
Foto referencial. Algunos productos, acabados o telas podrían ya no estar disponibles.

RUMBA SIDE CHAIR 400
silla s/b rumba 400

RM01-400

w 23^{1/2}" D 28" H 39^{1/4}" SH 19^{3/4}"
60 cm 71 cm 100 cm 50 cm

SW 20^{1/2}" SD 21^{1/4}" SD 22"
52 cm 54 cm 56 cm

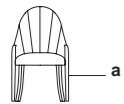
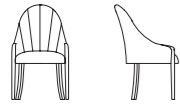

a: wood finish

Wood finish / Acabado madera



Referential photo. Some products, finishes or fabrics may no longer be available. /
Foto referencial. Algunos productos, acabados o telas podrían ya no estar disponibles.

RUMBA SIDE CHAIR 410
silla s/b rumba 410

RM01-410

w 23^{1/2}" D 28" H 39^{1/4}" SH 19^{3/4}"
60 cm 71 cm 100 cm 50 cm

sw 20^{1/2}" SD 21^{1/4}" AH 22"
52 cm 54 cm 56 cm

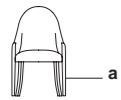
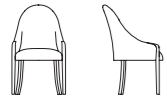

a: wood finish

Wood finish / Acabado madera



Referential photo. Some products, finishes or fabrics may no longer be available. /
Foto referencial. Algunos productos, acabados o telas podrían ya no estar disponibles.

TEN CHAIR 100
silla ten 100

TN01-100

w 22^{3/4"} D 25^{1/2"} H 33^{1/2"} SH 19^{3/4"}
58 cm 65 cm 85 cm 50 cm

sw 20^{1/2"} SD 20"
52 cm 51 cm AH 28"
71 cm

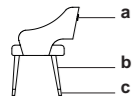
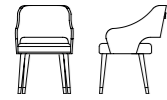

a:decorative hardware b:base finish c:metal finish

Metal finish / Acabado metálico



Decorative hardware / Herraje decorativo



Base finish / Acabado base



TEN SIDE CHAIR 110
silla s/b ten 100

TN01-110

w 19^{3/4"} D 25^{1/2"} H 33^{1/2"} SH 19^{3/4"}
50 cm 65 cm 85 cm 50 cm

sw 19^{3/4"} SD 20"
50 cm 51 cm



a:decorative hardware b:base finish c:metal finish

Metal finish / Acabado metálico



Decorative hardware / Herraje decorativo



Base finish / Acabado base

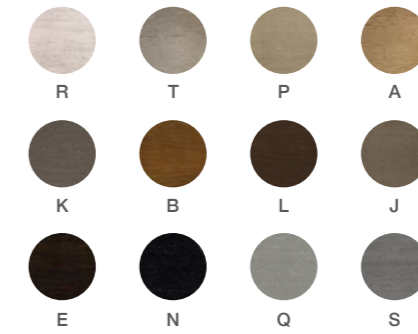

BAR & COUNTER STOOLS

bar y counter stools



CHOCOLATE BAR & COUNTER STOOL 120
bar & counter stool chocolate 120



GEM BAR & COUNTER STOOL 100
bar & counter stool gem 100



GRAFITO COUNTER STOOL 100
counter stool grafito 100



GRAFITO COUNTER STOOL 900
counter stool grafito 900



RUMBA BAR & COUNTER STOOL 100
bar & counter stool rumba 100



TEN BAR & COUNTER STOOL 100
bar & counter stool ten 100



TEN BAR & COUNTER STOOL 200
bar & counter stool ten 200

CHOCOLATE BAR STOOL 120 bar stool chocolate 120

CH03-120

W 20^{3/4"} D 22^{3/4"} H 41^{1/4"} SH 30"
53 cm 58 cm 105 cm 76 cm

SW 20^{3/4"} SD 18^{1/2"}
53 cm 47 cm

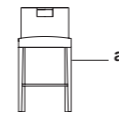
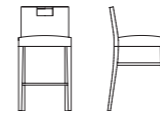

a:wood finish

CHOCOLATE COUNTER STOOL 120 counter stool chocolate 120

CH05-120

W 20^{3/4"} D 22^{3/4"} H 35^{1/2"} SH 26"
53 cm 58 cm 90 cm 66 cm

SW 20^{3/4"} SD 18^{1/2"}
53 cm 47 cm

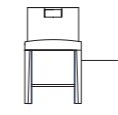
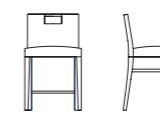

a:wood finish

Wood finish / Acabado madera



High traffic resistance finish available for foot-bar only /
Acabado de alto tráfico está disponible únicamente para la barra de pie inferior.

Slight color variations may occur while printing tear sheets due to printers pixelation and quality. Product specifications are subject to change due to product development updates. / Ligeras variaciones de color pueden ocurrir en la impresión. Las especificaciones están sujetas a cambios debido a las necesidades del producto.

Dimensions are usually approximated to the nearest quarter inch that will correspond to its metric conversion. / Las medidas generalmente se dan de acuerdo a la conversión métrica correspondiente y con una medida aproximada.

GEM BAR STOOL 100 (SWIVEL*)
bar stool gem 100 (mecanismo giratorio*)

GM03-100

w 19 1/4" D 22" H 41" SH 30"
49 cm 56 cm 104 cm 76 cm

sw 19 1/4" SD 17 3/4"
49 cm 45 cm



a: wood finish

GEM COUNTER STOOL 100 (SWIVEL*)
counter stool gem 100 (mecanismo giratorio*)

GM05-100

w 19 1/4" D 22" H 37" SH 26"
49 cm 56 cm 94 cm 66 cm

sw 19 1/4" SD 17 3/4"
49 cm 45 cm



a: wood finish

Wood finish / Acabado madera

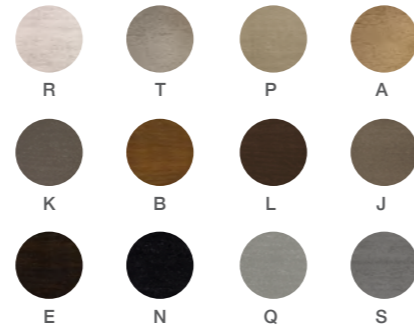

GRAFITO COUNTER STOOL 900
counter stool grafito 900

GT05-900

w 15" D 15" H 26"
38 cm 38 cm 66 cm

sw 15" SD 15"
38 cm 38 cm

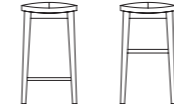

a: wood finish

Wood finish / Acabado madera

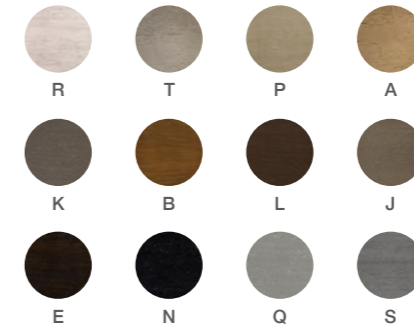

*Memory-Return Swivel / Mecanismo giratorio con memoria de retorno
High traffic resistance finish available for foot-bar only /
Acabado de alto tráfico está disponible únicamente para la barra de pie inferior.

High traffic resistance finish available for foot-bar only /
Acabado de alto tráfico está disponible únicamente para la barra de pie inferior.

RUMBA BAR STOOL 100 (SWIVEL*)
bar stool rumba 100
(mecanismo giratorio*)

RM03-100

W 22" D 22" H 40 1/4" SH 30"
56 cm 56 cm 102 cm 76 cm

SW 19 3/4" SD 19 3/4"
50 cm 50 cm

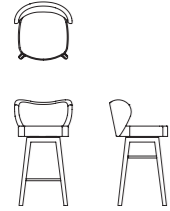

a:wood finish

RUMBA COUNTER STOOL 100 (SWIVEL*)
counter stool rumba 100
(mecanismo giratorio*)

RM05-100

W 22" D 22" H 35 1/2" SH 26"
56 cm 56 cm 90 cm 66 cm

SW 19 3/4" SD 19 3/4"
50 cm 50 cm

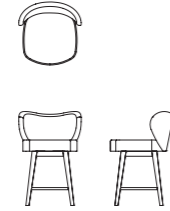

a:wood finish

Wood finish / Acabado madera



TEN BAR STOOL 100 (SWIVEL*)
bar stool ten 100
(mecanismo giratorio*)

TN03-100

W 20 1/2" D 23 1/2" H 41 1/4" SH 30"
52 cm 60 cm 105 cm 76 cm

SW 20 1/2" SD 19 1/4"
52 cm 49 cm



a:decorative hardware b:wood finish

TEN COUNTER STOOL 100 (SWIVEL*)
counter stool ten 100
(mecanismo giratorio*)

TN05-100

W 20 1/2" D 23 1/2" H 35 1/2" SH 26"
52 cm 60 cm 90 cm 66 cm

SW 20 1/2" SD 19 1/4"
52 cm 49 cm

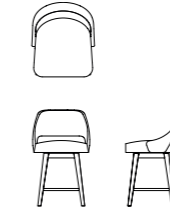

a:decorative hardware b:wood finish

Wood finish / Acabado madera



Decorative hardware / Herraje decorativo



*Memory-Return Swivel / Mecanismo giratorio con memoria de retorno
High traffic resistance finish available for foot-bar only /
Acabado de alto tráfico está disponible únicamente para la barra de pie inferior.



*Memory-Return Swivel / Mecanismo giratorio con memoria de retorno
High traffic resistance finish available for foot-bar only /
Acabado de alto tráfico está disponible únicamente para la barra de pie inferior.

TEN BAR STOOL 200 (SWIVEL*)
bar stool ten 200
(mecanismo giratorio*)

TN03-200

w 20^{1/2"} d 23^{1/2"} h 41^{1/4"} sh 30"
52 cm 60 cm 105 cm 76 cm

sw 20^{1/2"} sd 19^{1/4"}
52 cm 49 cm



a:wood finish

TEN COUNTER STOOL 200 (SWIVEL*)
counter stool ten 200
(mecanismo giratorio*)

TN05-200

w 20^{1/2"} d 23^{1/2"} h 35^{1/2"} sh 26"
52 cm 60 cm 90 cm 66 cm

sw 20^{1/2"} sd 19^{1/4"}
52 cm 49 cm



a:wood finish

Wood finish / Acabado madera



Piping detail / Detalle ribete

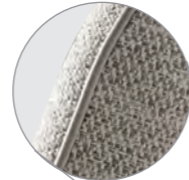

*Memory-Return Swivel / Mecanismo giratorio con memoria de retorno
Piping can be customized / El ribete puede personalizarse
High traffic resistance finish available for foot-bar only / Acabado de alto tráfico está disponible únicamente para la barra de pie inferior.



Referential photo. Some products, finishes or fabrics may no longer be available. / Foto referencial. Algunos productos, acabados o telas podrían ya no estar disponibles.

BUFFETS aparadores



BOLERO BUFFET 100
aparador bolero 100



BOLERO BULL 310
bull bolero 310



CAFE BUFFET 400
aparador café 400



CAFE BUFFET 402
aparador café 402



CAMELO BUFFET 710
aparador caramelo 710



GEM BULL 101
bull gem 101



GALAPAGOS BUFFET 100
aparador galapagos 100



GALAPAGOS BUFFET 101
aparador galapagos 101



RUMBA BUFFET 100
aparador rumba 100



RUMBA BUFFET 300
aparador rumba 300

BOLERO BUFFET 100 aparador bolero 100

BR07-100

w 70^{3/4"} D 19^{3/4"} H 31^{1/2"}
180 cm 50 cm 80 cm

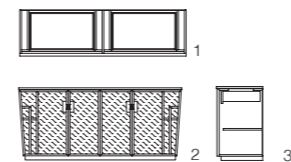

Exterior view 1: plan 2: front 3: side
Vista externa 1: superior 2: frontal 3: lateral

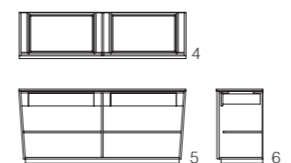

Interior view 4: plan 5: front 6: side
Vista interna 4: superior 5: frontal 6: lateral

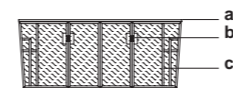

a: wood finish b: pull c: door insert

Wood finish / Acabado madera

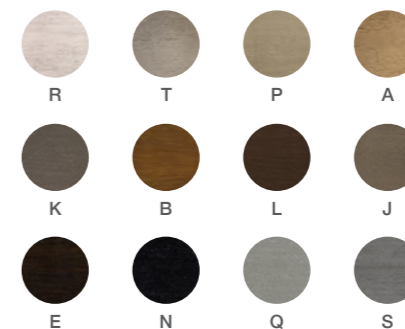

Door insert / Inserto puertas



Pull / Tiradera

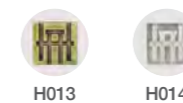

Slight color variations may occur while printing tear sheets due to printers pixelation and quality. Product specifications are subject to change due to product development updates. / Ligeras variaciones de color pueden ocurrir en la impresión. Las especificaciones están sujetas a cambios debido a las necesidades del producto.

Dimensions are usually approximated to the nearest quarter inch that will correspond to its metric conversion. / Las medidas generalmente se dan de acuerdo a la conversión métrica correspondiente y con una medida aproximada.

*The leather is applicable only in specific details / El cuero es aplicable únicamente en detalles específicos

BOLERO BULL 310
bull bolero 310

BR30-310

w 35^{1/2"} D 17^{3/4"} H 33^{1/2"}
90 cm 45 cm 85 cm

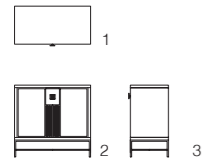

Exterior view 1: plan 2: front 3: side
Vista externa 1: superior 2: frontal 3: lateral

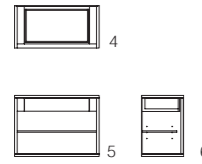

Interior view 4: plan 5: front 6: side
Vista interna 4: superior 5: frontal 6: lateral

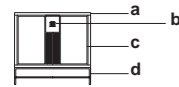

a: wood finish b: pull c: front finish d: metal finish

Wood finish / Acabado madera
Front finish / Acabado frente

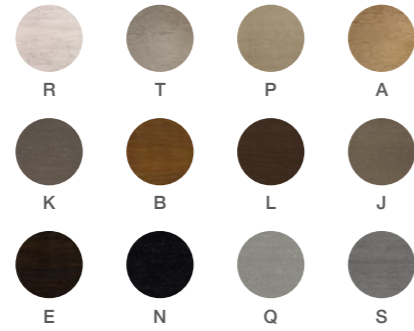

Metal finish / Acabado metal



Pull / Tiraderas

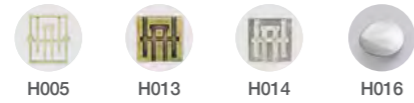

CAFE BUFFET 400
aparador café 400

CF07-400

w 72" D 20^{1/2"} H 32"
183 cm 52 cm 81 cm

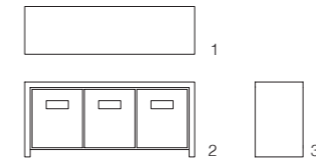

Exterior view 1: plan 2: front 3: side
Vista externa 1: superior 2: frontal 3: lateral

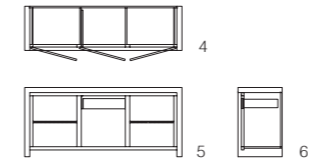

Interior view 4: plan 5: front 6: side
Vista interna 4: superior 5: frontal 6: lateral

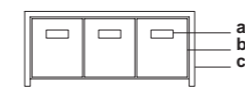

a: pull b: front finish c: wood finish

Wood finish / Acabado madera
Front finish / Acabado frente

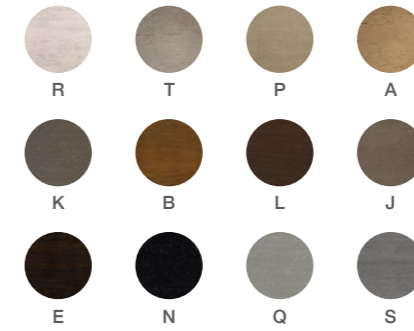

Pull / Tiraderas

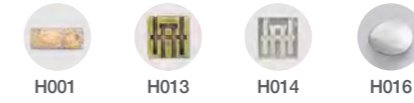

CAFE BUFFET 402
aparador café 402

CF07-402

W 72" D 20 1/2" H 32"
183 cm 52 cm 81 cm

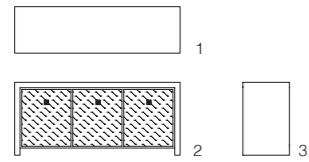

Exterior view 1: plan 2: front 3: side
Vista externa 1: superior 2: frontal 3: lateral

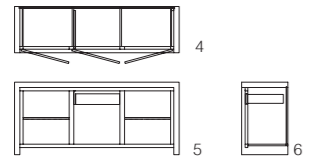

Interior view 4: plan 5: front 6: side
Vista interna 4: superior 5: frontal 6: lateral

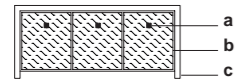

a: pull b: door insert c: wood finish

Wood finish / Acabado madera

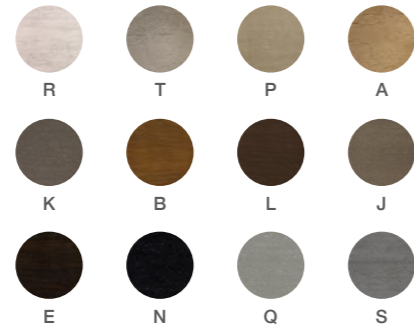

Door insert / Inserto puertas

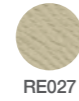

Pull / Tiradera

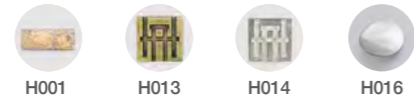

*The leather is applicable only in specific details /
El cuero es aplicable únicamente en detalles específicos

CARAMELO BUFFET 710
aparador caramelo 710

CM07-710

W 79 1/4" D 21 3/4" H 32 1/4"
201 cm 55 cm 82 cm

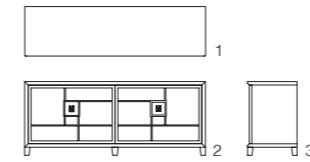

Exterior view 1: plan 2: front 3: side
Vista externa 1: superior 2: frontal 3: lateral

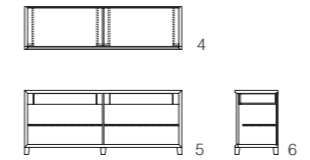

Interior view 4: plan 5: front 6: side
Vista interna 4: superior 5: frontal 6: lateral

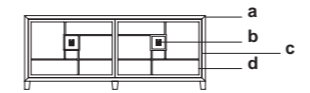

a: wood finish b: pull c: wooden detail d: front finish

Wood finish / Acabado madera

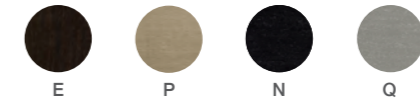

Pull / Tiradera

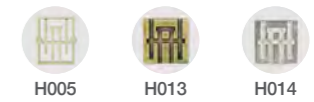

Front finish / Acabado frente



Wooden detail / Detalle madera:



GEM BULL 101 (STONE TOP)
bull gem 101 (top de piedra)

GM30-101

w 39^{1/4"} d 17^{3/4"} h 32^{3/4"}
100 cm 45 cm 83 cm

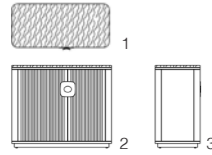

Exterior view 1: plan 2: front 3: side
Vista externa 1: superior 2: frontal 3: lateral

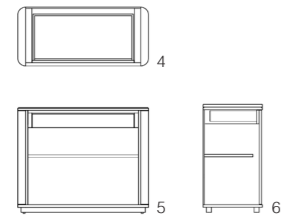

Interior view 4: plan 5: front 6: side
Vista interna 4: superior 5: frontal 6: lateral

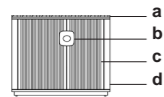

a:stone top b:pull c:front finish d:wood finish

Stone top / Top piedra



PULL / TIRADERA

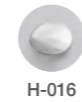

Front finish / Acabado frente

Wood finish / Acabado madera

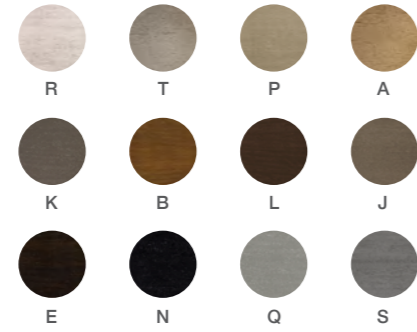

Referential photo. Some products, finishes or fabrics may no longer be available. / Foto referencial. Algunos productos, acabados o telas podrían ya no estar disponibles.

**GALAPAGOS
BUFFET 100**
aparador galápagos 100

GS07-100

W 70^{3/4"} D 20^{1/2"} H 30"
180 cm 52 cm 76 cm

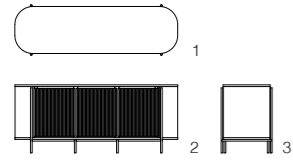

Exterior view 1: plan 2: front 3: side
Vista externa 1: superior 2: frontal 3: lateral

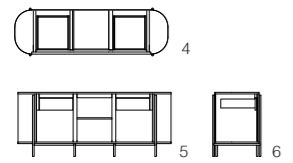

Interior view 4: plan 5: front 6: side
Vista interna 4: superior 5: frontal 6: lateral

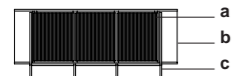

a: front finish b: wood finish c: metal finish

Front finish / Acabado frente
Wood finish / Acabado madera



Metal finish / Acabado metal



**GALAPAGOS BUFFET
101 (STONE TOP)**
aparador galápagos 101
(top piedra)

GS07-101

W 70^{3/4"} D 20^{1/2"} H 30^{3/4"}
180 cm 52 cm 78 cm

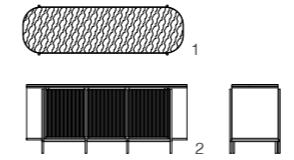

Exterior view 1: plan 2: front 3: side
Vista externa 1: superior 2: frontal 3: lateral

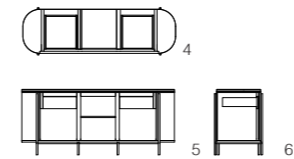

Interior view 4: plan 5: front 6: side
Vista interna 4: superior 5: frontal 6: lateral

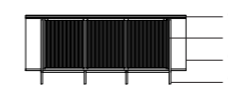

a: stone top b: front finish c: wood finish d: metal finish

Stone top / Top piedra



Front finish / Acabado frente
Wood finish / Acabado madera

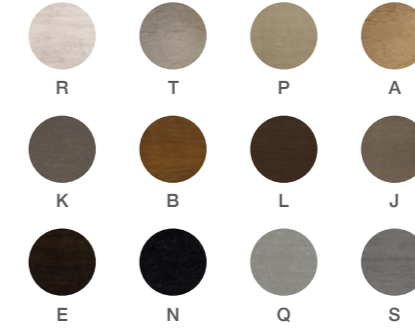

Metal finish / Acabado metal

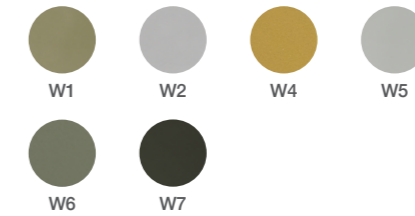



Referential photo. Some products, finishes or fabrics may no longer be available. /
Foto referencial. Algunos productos, acabados o telas podrían ya no estar disponibles.

DINING ROOM | COMEDOR

 ADRIANA HOYOS

RUMBA BUFFET 100
aparador rumba 100

RM07-100

W 72" D 20 1/2" H 32"
183 CM 52 CM 81 CM

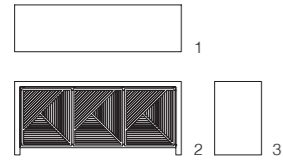

Exterior view 1: plan 2: front 3: side
Vista externa 1: superior 2: frontal 3: lateral

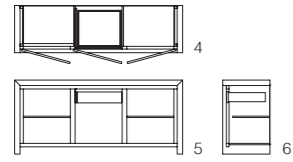

Interior view 4: plan 5: front 6: side
Vista interna 4: superior 5: frontal 6: lateral



a: front finish c: wood finish

Front finish / Acabado frente
Wood finish / Acabado madera

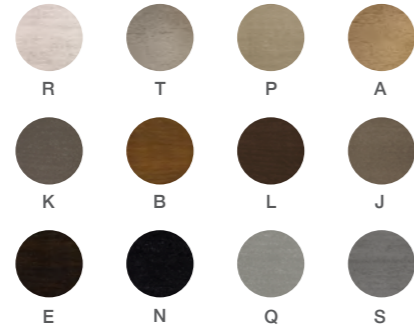

Referential photo. Some products, finishes or fabrics may no longer be available. /
Foto referencial. Algunos productos, acabados o telas podrían ya no estar disponibles.

RUMBA BUFFET 300
aparador rumba 300

RM07-300

W 70^{3/4"} D 20"
180 CM 51 CM H 32^{1/4"}
82 CM

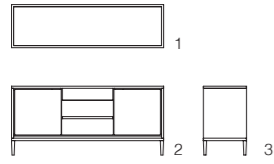

Exterior view 1: plan 2: front 3: side
Vista externa 1: superior 2: frontal 3: lateral

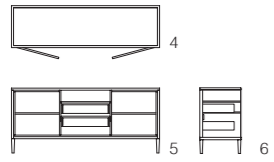

Interior view 4: plan 5: front 6: side
Vista interna 4: superior 5: frontal 6: lateral

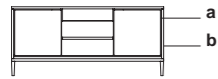

a: front finish c: wood finish

Front finish / Acabado frente
Wood finish / Acabado madera

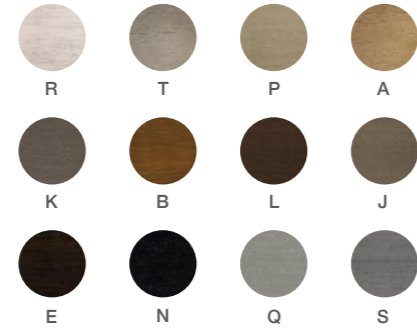

BEDROOM | DORMITORIO



BEDS

camas



AFRICA BED 500/501/502
cama áfrica 500/501/502



AFRICA BED 510/511/512
cama áfrica 510/511/512



CAMELO QUILTED BED 130/131/132
cama capitoneada caramelo 130/131/132



CAMELO QUILTED BED 140/141/142
cama capitoneada caramelo 140/141/142



GEM UPHOLSTERED BED WITH PANELS 100/101/102
cama tapizada con paneles gem 100/101/102



GEM UPHOLSTERED BED 110/111/112
cama tapizada gem 110/111/112



GEM UPHOLSTERED BED WITH PANELS 200/201/202
cama tapizada con paneles gem 200/201/202



GEM UPHOLSTERED BED 210/211/212
cama tapizada gem 210/211/212



GALAPAGOS UPHOLSTERED BED 100/101/102
cama galapagos tapizada 100/101/102



H UPHOLSTERED BED 100/101
cama tapizada h 100/101

BEDS

camas



H BED 200/201
cama h 200/201



H UPHOLSTERED BED 400/401
cama tapizada h 400/401



H BED 500/501
cama h 500/501



H BED WITH PANELS 510/511
cama con paneles h 510/511



RUMBA BED 400/401/402
cama rumba 400/401/402



RUMBA BED 410/411/412
cama rumba 410/411/412



RUMBA BED 211
cama rumba 211

Slight color variations may occur while printing tear sheets due to printers pixelation and quality. Product specifications are subject to change due to product development updates. / Ligeras variaciones de color pueden ocurrir en la impresión. Las especificaciones están sujetas a cambios debido a las necesidades del producto.

Dimensions are usually approximated to the nearest quarter inch that will correspond to its metric conversion. / Las medidas generalmente se dan de acuerdo a la conversión métrica correspondiente y con una medida aproximada.

Slight color variations may occur while printing tear sheets due to printers pixelation and quality. Product specifications are subject to change due to product development updates. / Ligeras variaciones de color pueden ocurrir en la impresión. Las especificaciones están sujetas a cambios debido a las necesidades del producto.

Dimensions are usually approximated to the nearest quarter inch that will correspond to its metric conversion. / Las medidas generalmente se dan de acuerdo a la conversión métrica correspondiente y con una medida aproximada.

**AFRICA KING/QUEEN BED
(WOOD SIDE RAILS & FOOTBOARD)**

cama king/queen áfrica

US STANDARD

AF26-501K

platform

W 85" D 84 1/4" H 63"
216 cm 214 cm 160 cm

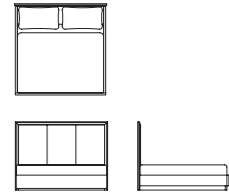

AF26-501Q

platform

W 69 1/4" D 84 1/4" H 63"
176 cm 214 cm 160 cm

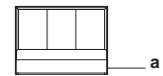
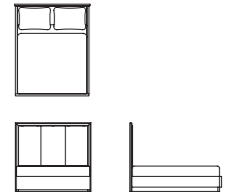

a: wood finish

US STANDARD BOX SPRING

AF26-502K

requires box spring

W 85" D 84 1/4" H 63"
216 cm 214 cm 160 cm

AF26-502Q

requires box spring

W 69 1/4" D 84 1/4" H 63"
176 cm 214 cm 160 cm

ECUADOR STANDARD

AF26-500K

W 85" D 84 1/4" H 63"
216 cm 214 cm 160 cm

AF26-500Q

W 69 1/4" D 84 1/4" H 63"
176 cm 214 cm 160 cm

Wood finish / Acabado madera



**AFRICA KING/QUEEN BED
(UPHOLSTERED SIDE RAILS & FOOTBOARD)**

cama king/queen áfrica

US STANDARD

AF26-511K

platform

W 85" D 84 1/4" H 63"
216 cm 214 cm 160 cm

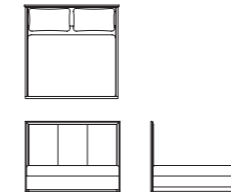

AF26-511Q

platform

W 69 1/4" D 84 1/4" H 63"
176 cm 214 cm 160 cm

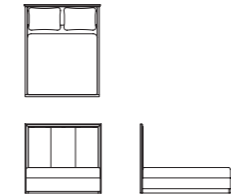

a: wood finish

US STANDARD BOX SPRING

AF26-512K

requires box spring

W 85" D 84 1/4" H 63"
216 cm 214 cm 160 cm

AF26-512Q

requires box spring

W 69 1/4" D 84 1/4" H 63"
176 cm 214 cm 160 cm

ECUADOR STANDARD

AF26-510K

W 85" D 84 1/4" H 63"
216 cm 214 cm 160 cm

AF26-510Q

W 69 1/4" D 84 1/4" H 63"
176 cm 214 cm 160 cm

Wood finish / Acabado madera



CAMELO QUILTED KING/QUEEN BED
cama capitoneada king/queen Caramelo

US STANDARD

CM26-131K
platform

W 82^{1/4}" D 83^{3/4}" H 57"
209 cm 213 cm 145 cm

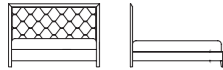
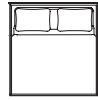

CM26-131Q
platform

W 66^{1/4}" D 83^{3/4}" H 57"
168 cm 213 cm 145 cm

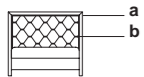
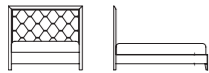
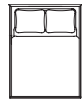

a:wood finish b:decorative plate

US STANDARD BOX SPRING

CM26-132K
requires box spring

W 82^{1/4}" D 83^{3/4}" H 57"
209 cm 213 cm 145 cm

CM26-132Q
requires box spring

W 66^{1/4}" D 83^{3/4}" H 57"
168 cm 213 cm 145 cm

ECUADOR STANDARD

CM26-130K

W 85" D 83^{3/4}" H 57"
216 cm 213 cm 145 cm

CM26-130Q

W 69^{1/4}" D 83^{3/4}" H 57"
176 cm 213 cm 145 cm

Wood finish / Acabado madera



Decorative plate / Placa decorativa

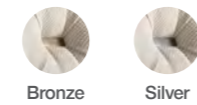

Quilted headboard to be upholstered on the following fabrics and leathers: 1-CN022, 1-CN23, 1-KT044, 1-CN042, 1-CN044 or Milan Portofino leathers. / Espaldar capitoneado puede ser tapizado en las siguientes telas y cueros: 1-CN022, 1-CN23, 1-KT044, 1-CN042, 1-CN044 o cueros Milan Portofino.

CAMELO QUILTED KING/QUEEN BED
cama capitoneada king/queen caramelo

US STANDARD

CM26-141K
platform

W 82^{1/4}" D 83^{3/4}" H 70"
209 cm 213 cm 178 cm

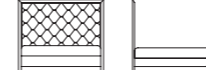
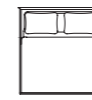

CM26-141Q
platform

W 66^{1/4}" D 83^{3/4}" H 70"
168 cm 213 cm 178 cm

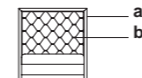
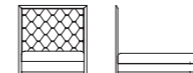

a:wood finish b:decorative plate



Quilted headboard to be upholstered on the following fabrics and leathers: 1-CN022, 1-CN23, 1-KT044, 1-CN042, 1-CN044 or Milan Portofino leathers. / Espaldar capitoneado puede ser tapizado en las siguientes telas y cueros: 1-CN022, 1-CN23, 1-KT044, 1-CN042, 1-CN044 o cueros Milan Portofino.

GEM UPHOLSTERED WITH PANELS KING/QUEEN BED
 cama tapizada con paneles king/queen gem

US STANDARD

GM26-101K
 platform

W 167^{3/4}" D 87^{1/2}" H 47^{1/4}"
 426 cm 222 cm 120 cm

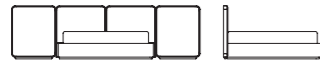
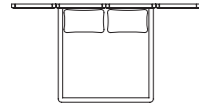

GM26-101Q
 platform

W 152" D 87^{1/2}" H 47^{1/4}"
 386 cm 222 cm 120 cm

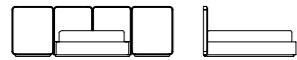
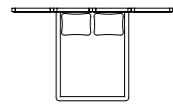

a: wood finish



US STANDARD BOX SPRING

GM26-102K
 requires box spring

W 167^{3/4}" D 87^{1/2}" H 47^{1/4}"
 426 cm 222 cm 120 cm

GM26-102Q
 requires box spring

W 152" D 87^{1/2}" H 47^{1/4}"
 386 cm 222 cm 120 cm

ECUADOR STANDARD

GM26-100K

W 167^{3/4}" D 87^{1/2}" H 47^{1/4}"
 426 cm 222 cm 120 cm

GM26-100Q

W 152" D 87^{1/2}" H 47^{1/4}"
 386 cm 222 cm 120 cm

Wood finish / Acabado madera



BW: box width | BD: box depth / BW: ancho de box | BD: profundidad de box



Referential photo. Some products, finishes or fabrics may no longer be available. /
 Foto referencial. Algunos productos, acabados o telas podrían ya no estar disponibles.

GEM UPHOLSTERED KING/QUEEN BED

cama tapizada king/queen gem

US STANDARD

GM26-111K
platform

W 89" D 87 1/2" H 47 1/4"
226 cm 222 cm 120 cm

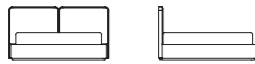
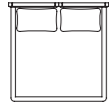

GM26-111Q
platform

W 73 1/4" D 87 1/2" H 47 1/4"
186 cm 222 cm 120 cm

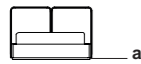
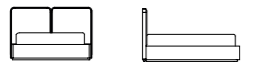
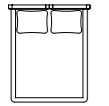

a: wood finish

US STANDARD BOX SPRING

GM26-112K
requires box spring

W 89" D 87 1/2" H 47 1/4"
226 cm 222 cm 120 cm

GM26-112Q
requires box spring

W 73 1/4" D 87 1/2" H 47 1/4"
186 cm 222 cm 120 cm

ECUADOR STANDARD

GM26-110K

W 89" D 87 1/2" H 47 1/4"
226 cm 222 cm 120 cm

GM26-110Q

W 73 1/4" D 87 1/2" H 47 1/4"
186 cm 222 cm 120 cm

Wood finish / Acabado madera



GEM UPHOLSTERED WITH PANELS KING/QUEEN BED

cama tapizada con paneles king/queen gem

US STANDARD

GM26-201K
platform

W 167 3/4" D 87 1/2" H 63"
426 cm 222 cm 160 cm

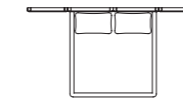

GM26-201Q
platform

W 152" D 87 1/2" H 63"
386 cm 222 cm 160 cm

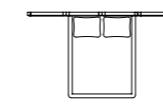

a: wood finish

US STANDARD BOX SPRING

GM26-202K
requires box spring

W 167 3/4" D 87 1/2" H 63"
426 cm 222 cm 160 cm

GM26-202Q
requires box spring

W 152" D 87 1/2" H 63"
386 cm 222 cm 160 cm

ECUADOR STANDARD

GM26-200K

W 167 3/4" D 87 1/2" H 63"
426 cm 222 cm 160 cm

GM26-200Q

W 152" D 87 1/2" H 63"
386 cm 222 cm 160 cm

Wood finish / Acabado madera



BW: box width | BD: box depth / BW: ancho de box | BD: profundidad de box



Referential photo. Some products, finishes or fabrics may no longer be available. /
Foto referencial. Algunos productos, acabados o telas podrían ya no estar disponibles.

GEM UPHOLSTERED KING/QUEEN BED
cama tapizada king/queen gem

US STANDARD

GM26-211K
platform

W 89" D 87 1/2" H 63"
226 cm 222 cm 160 cm

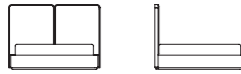

GM26-211Q
platform

W 73 1/4" D 87 1/2" H 63"
186 cm 222 cm 160 cm

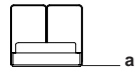
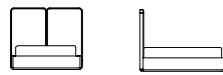

a: wood finish

US STANDARD BOX SPRING

GM26-212K
requires box spring

W 89" D 87 1/2" H 63"
226 cm 222 cm 160 cm

GM26-212Q
requires box spring

W 73 1/4" D 87 1/2" H 63"
186 cm 222 cm 160 cm

ECUADOR STANDARD

GM26-210K

W 89" D 87 1/2" H 63"
226 cm 222 cm 160 cm

GM26-210Q

W 73 1/4" D 87 1/2" H 63"
186 cm 222 cm 160 cm

Wood finish / Acabado madera

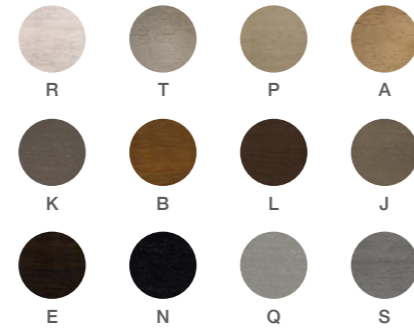

GALAPAGOS UPHOLSTERED KING/QUEEN BED
cama tapizada king/queen galapagos

US STANDARD

GS26-101K
platform

W 102 1/4" D 85 3/4" H 47 1/4"
260 cm 218 cm 120 cm

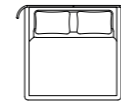

GS26-101Q
platform

W 86 1/2" D 85 3/4" H 47 1/4"
220 cm 218 cm 120 cm

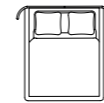

a: wood finish



US STANDARD BOX SPRING

GS26-102K
requires box spring

W 102 1/4" D 85 3/4" H 47 1/4"
260 cm 218 cm 120 cm

GS26-102Q
requires box spring

W 86 1/2" D 85 3/4" H 47 1/4"
220 cm 218 cm 120 cm

ECUADOR STANDARD

GS26-100K

W 102 1/4" D 85 3/4" H 47 1/4"
260 cm 218 cm 120 cm

GS26-100Q

W 86 1/2" D 85 3/4" H 47 1/4"
220 cm 218 cm 120 cm

Wood finish / Acabado madera





Referential photo. Some products, finishes or fabrics may no longer be available. /
Foto referencial. Algunos productos, acabados o telas podrían ya no estar disponibles.

**H UPHOLSTERED KING/
QUEEN BED**
cama tapizada king/queen h

US STANDARD

HS26-101K
platform

W 80" D 85³/₄" H 47¹/₄"
203 cm 218 cm 120 cm

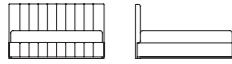
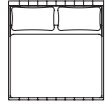

HS26-101Q
platform

W 63³/₄" D 85³/₄" H 47¹/₄"
162 cm 218 cm 120 cm

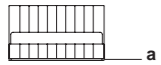
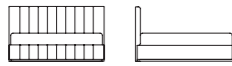
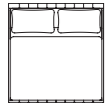

a: wood finish

ECUADOR STANDARD

HS26-100K

W 82³/₄" D 85³/₄" H 47¹/₄"
210 cm 218 cm 120 cm

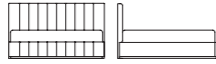
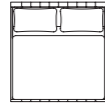

HS26-100Q

W 67" D 85³/₄" H 47¹/₄"
170 cm 218 cm 120 cm

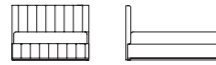
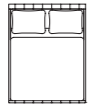

Wood finish / Acabado madera



H KING/QUEEN BED
cama king/queen h

US STANDARD

HS26-201K
platform

W 80" D 84¹/₄" H 51¹/₄"
203 cm 214 cm 130 cm

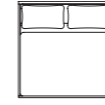

HS26-201Q
platform

W 63³/₄" D 84¹/₄" H 51¹/₄"
162 cm 214 cm 130 cm



a: wood finish

ECUADOR STANDARD

HS26-200K

W 82³/₄" D 84¹/₄" H 51¹/₄"
210 cm 214 cm 130 cm

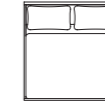

HS26-200Q

W 67" D 84¹/₄" H 51¹/₄"
170 cm 214 cm 130 cm

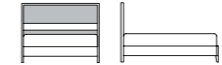

Wood finish / Acabado madera



**H UPHOLSTERED KING/
QUEEN BED**
cama tapizada king/queen H

US STANDARD

HS26-401K
platform

W 84^{3/4}" D 92^{1/4}" H 39^{1/4}"
215 cm 234 cm 100 cm

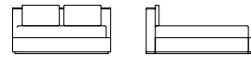
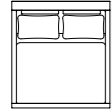

HS26-401Q
platform

W 68^{1/2}" D 92^{1/4}" H 39^{1/4}"
174 cm 234 cm 100 cm

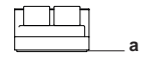
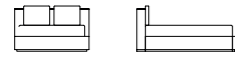
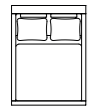

a: wood finish

ECUADOR STANDARD

HS26-400K

W 87^{1/2}" D 92^{1/4}" H 39^{1/4}"
222 cm 234 cm 100 cm

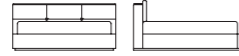
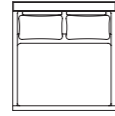

HS26-400Q

W 71^{3/4}" D 92^{1/4}" H 39^{1/4}"
182 cm 234 cm 100 cm

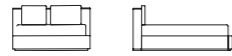
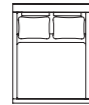

Wood finish / Acabado madera



H KING/QUEEN BED
cama king/queen H

US STANDARD

HS26-501K
platform

W 82^{1/2}" D 84^{1/4}" H 47^{1/4}"
210 cm 214 cm 120 cm

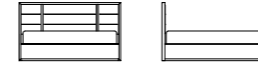

HS26-501Q
platform

W 67" D 84^{1/4}" H 47^{1/4}"
170 cm 214 cm 120 cm

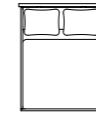

a: wood finish

ECUADOR STANDARD

HS26-500K

W 82^{1/2}" D 84^{1/4}" H 47^{1/4}"
210 cm 214 cm 120 cm

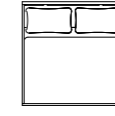

HS26-500Q

W 67" D 84^{1/4}" H 47^{1/4}"
170 cm 214 cm 120 cm

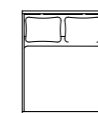

Wood finish / Acabado madera



Two back pillow included / Incluye dos cojines de espalda



H KING/QUEEN WITH PANELS BED

cama con paneles king/queen H

US STANDARD

HS26-511K
platform

W 145^{1/2}" D 84^{1/4}" H 47^{1/4}"
370 cm 214 cm 120 cm

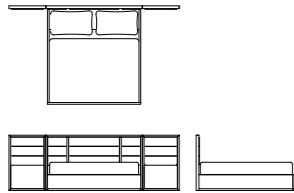

HS26-511Q
platform

W 130" D 84^{1/4}" H 47^{1/4}"
330 cm 214 cm 120 cm

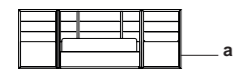
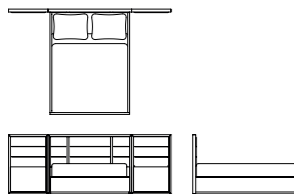

a: wood finish

ECUADOR STANDARD

HS26-510K

W 145^{1/2}" D 84^{1/4}" H 47^{1/4}"
370 cm 214 cm 120 cm

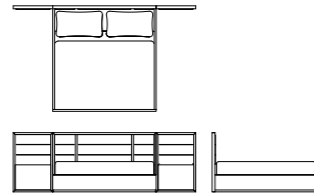

HS26-510Q

W 130" D 84^{1/4}" H 47^{1/4}"
330 cm 214 cm 120 cm

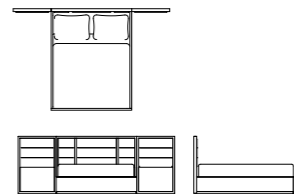

Wood finish / Acabado madera



RUMBA KING/QUEEN BED (WOOD SIDE RAILS & FOOTBOARD)

cama king/queen rumba

US STANDARD

RM26-401K
platform

W 85" D 84^{1/4}" H 63"
216 cm 214 cm 160 cm

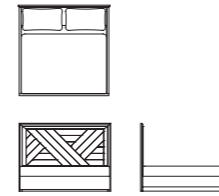

RM26-401Q
platform

W 69^{1/4}" D 84^{1/4}" H 63"
176 cm 214 cm 160 cm

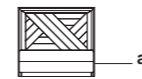
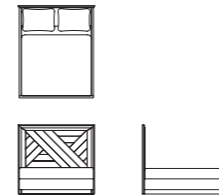

a: wood finish

US STANDARD BOX SPRING

RM26-402K
requires box spring

W 85" D 84^{1/4}" H 63"
216 cm 214 cm 160 cm

RM26-402Q
requires box spring

W 69^{1/4}" D 84^{1/4}" H 63"
176 cm 214 cm 160 cm

ECUADOR STANDARD

RM26-400K

W 85" D 84^{1/4}" H 63"
216 cm 214 cm 160 cm

RM26-400Q

W 69^{1/4}" D 84^{1/4}" H 63"
176 cm 214 cm 160 cm

Wood finish / Acabado madera



BW: box width | BD: box depth / BW: ancho de box | BD: profundidad de box



Referential photo. Some products, finishes or fabrics may no longer be available. /
Foto referencial. Algunos productos, acabados o telas podrían ya no estar disponibles.

**RUMBA KING/QUEEN BED
(UPHOLSTERED SIDE
RAILS& FOOTBOARD)**
cama king/queen rumba

US STANDARD

RM26-411K
platform

W 85" D 84^{1/4}" H 63"
216 cm 214 cm 160 cm

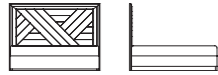

RM26-411Q
platform

W 69^{1/4}" D 84^{1/4}" H 63"
176 cm 214 cm 160 cm

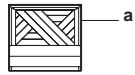
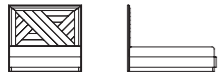

a:wood finish



US STANDARD BOX SPRING

RM26-412K
requires box spring

W 85" D 84^{1/4}" H 63"
216 cm 214 cm 160 cm

RM26-412Q
requires box spring

W 69^{1/4}" D 84^{1/4}" H 63"
176 cm 214 cm 160 cm

ECUADOR STANDARD

RM26-410K

W 85" D 84^{1/4}" H 63"
216 cm 214 cm 160 cm

RM26-410Q

W 69^{1/4}" D 84^{1/4}" H 63"
176 cm 214 cm 160 cm

Wood finish / Acabado madera



**RUMBA KING/QUEEN BED
211 (UPHOLSTERED SIDE
RAILS& FOOTBOARD)**
cama king/queen rumba 211

US STANDARD

RM26-211K
platform

W 83^{3/4}" D 83^{3/4}" H 69"
213 cm 213 cm 175 cm

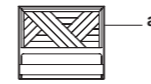

a:wood finish

Wood finish / Acabado madera

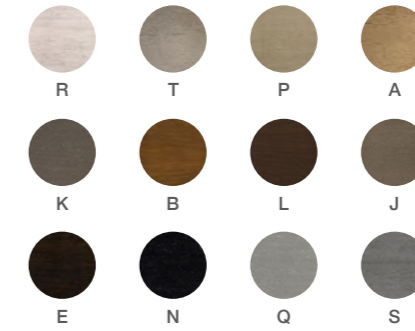

NIGHTSTANDS veladores



AFRICA NIGHTSTAND 420/441
velador áfrica 420/441



BOLERO NIGHTSTAND 100
velador bolero 100



GEM NIGHTSTAND 101/301
velador gem 101/301



GEM NIGHTSTAND 111/311
velador gem 111/311



GEM NIGHTSTAND 200
velador gem 200



GEM NIGHTSTAND 201
velador gem 201



GEM NIGHTSTAND 210
velador gem 210



GEM NIGHTSTAND 211
velador gem 211



GALAPAGOS NIGHTSTAND 200
velador galápagos 200



GALAPAGOS NIGHTSTAND 210
velador galápagos 210



H NIGHTSTAND 100
velador h 100



H NIGHTSTAND 200
velador h 200

NIGHTSTANDS veladores



H NIGHTSTAND 300
velador h 300



RUMBA NIGHTSTAND 100
velador rumba 100



RUMBA NIGHTSTAND 210
velador rumba 210



RUMBA NIGHTSTAND 300
velador rumba 300



TEN NIGHTSTAND 201
velador ten 201

Slight color variations may occur while printing tear sheets due to printers pixelation and quality. Product specifications are subject to change due to product development updates. / Ligeras variaciones de color pueden ocurrir en la impresión. Las especificaciones están sujetas a cambios debido a las necesidades del producto.

Dimensions are usually approximated to the nearest quarter inch that will correspond to its metric conversion. / Las medidas generalmente se dan de acuerdo a la conversión métrica correspondiente y con una medida aproximada.

Slight color variations may occur while printing tear sheets due to printers pixelation and quality. Product specifications are subject to change due to product development updates. / Ligeras variaciones de color pueden ocurrir en la impresión. Las especificaciones están sujetas a cambios debido a las necesidades del producto.

Dimensions are usually approximated to the nearest quarter inch that will correspond to its metric conversion. / Las medidas generalmente se dan de acuerdo a la conversión métrica correspondiente y con una medida aproximada.

AFRICA NIGHTSTAND 420 (STONE TOP)
velador áfrica 420 (top piedra)

AF28-420

w 32" D 19^{3/4}" H 26^{3/4}"
81 cm 50 cm 68 cm

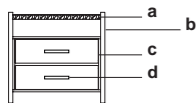
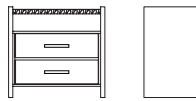
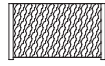

a:stone top b:base finish c:front finish d:pull

AFRICA NIGHTSTAND 441 (STONE TOP)
velador áfrica 441 (top piedra)

AF28-441

w 33^{3/4}" D 19^{3/4}" H 32"
86 cm 50 cm 81 cm

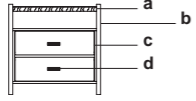
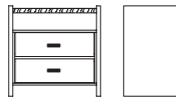
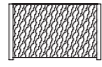

a:stone top b:base finish c:front finish d:pull

Stone top / Top piedra



Front finish / Acabado frente

Base finish / Acabado madera



Pull / Tiradera

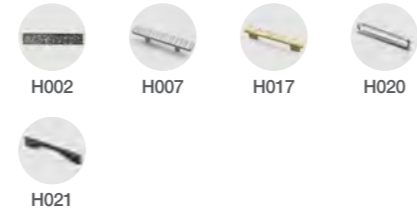

BOLERO NIGHTSTAND 100 (GLASS TOP)
velador bolero 100 (top vidrio)

BR28-100

w 31^{1/2}" D 19^{3/4}" H 25^{1/2}"
80 cm 50 cm 65 cm

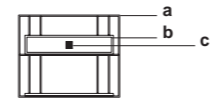
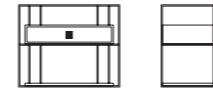

a:metal finish b:wood finish c:pull

Metal finish / Acabado metal

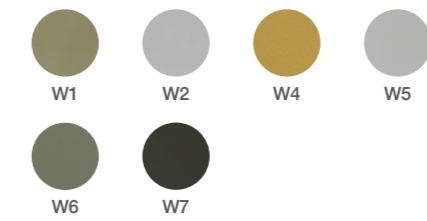

Wood finish / Acabado madera

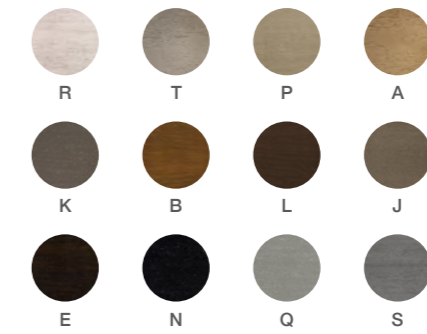

Pull / Tiradera

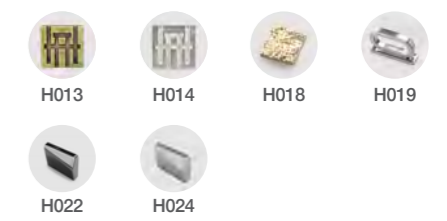

Glass Top included / Incluye top de vidrio

GEM NIGHTSTAND 101 (STONE TOP)
velador gem 101
(top piedra)

GM28-101

w 31^{1/2}" d 19^{3/4}" h 23^{1/2}"
80 cm 50 cm 60 cm

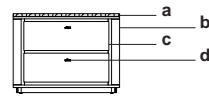
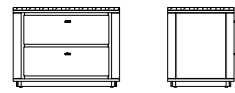
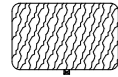

a:stone top b:wood finish c:front finish d:pull

GEM NIGHTSTAND 301 (STONE TOP)
velador gem 301
(top piedra)

GM28-301

w 35^{1/2}" d 19^{3/4}" h 28"
90 cm 50 cm 71 cm

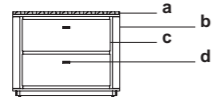
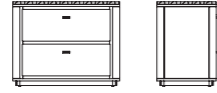
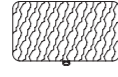

a:stone top b:wood finish c:front finish d:pull



Stone top / Top piedra

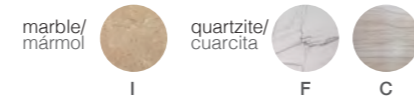

Wood finish / Acabado madera



Front finish / Acabado frente



Pull / Tiradera

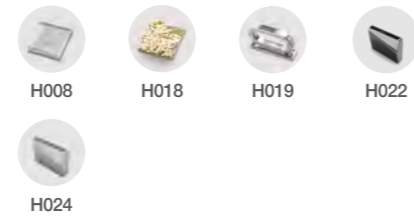

Product can be customized with or without pulls. / Producto puede personalizarse con o sin tiraderas.

Referential photo. Some products, finishes or fabrics may no longer be available. / Foto referencial. Algunos productos, acabados o telas podrían ya no estar disponibles.

GEM NIGHTSTAND 111
(STONE TOP)
velador gem 111
(top piedra)

GM28-111

w 31^{1/2}" D 19^{3/4}" H 23^{1/2}"
80 cm 50 cm 60 cm

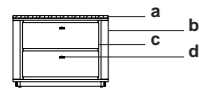
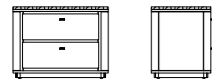
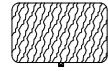

a:stone top b:wood finish c:front finish d:pull

GEM NIGHTSTAND 311
(STONE TOP)
velador gem 311
(top piedra)

GM28-311

w 35^{1/2}" D 19^{3/4}" H 28"
90 cm 50 cm 71 cm

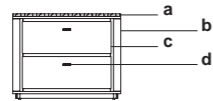
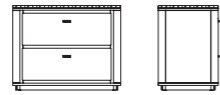
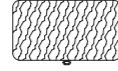

a:stone top b:wood finish c:front finish d:pull

Stone top / Top piedra

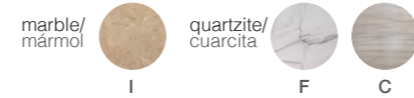

Front finish / Acabado frente

Wood finish / Acabado madera



Pull / Tiradera

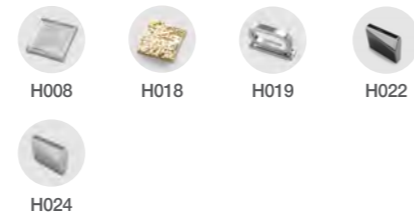

Product can be customized with or without pulls. / Producto puede personalizarse con o sin tiraderas.

Referential photo: Some products, finishes or fabrics may no longer be available. / Foto referencial: Algunos productos, acabados o telas podrían ya no estar disponibles.

GEM NIGHTSTAND 200
velador gem 200

GM28-200

w 35^{1/2}" d 19^{3/4}" h 30"
90 cm 50 cm 76 cm

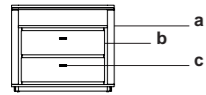
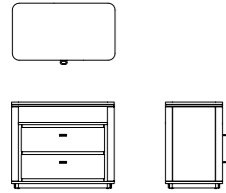

a:wood finish b:front finish c:pull

Wood finish / Acabado madera

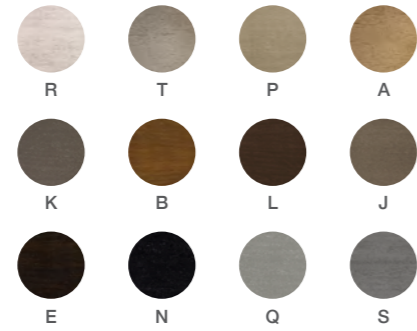

Front finish / Acabado frente



Pull / Tiradera

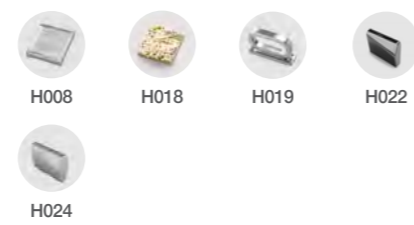

GEM NIGHTSTAND 201
(STONE TOP)
velador gem 201
(top piedra)

GM28-201

w 35^{1/2}" d 19^{3/4}" h 30"
90 cm 50 cm 76 cm

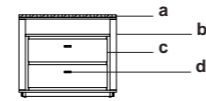
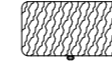

a:stone top b:wood finish c:front finish d:pull

Stone top / Top piedra

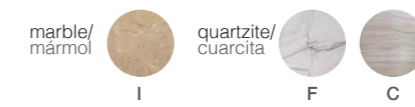

Wood finish / Acabado madera

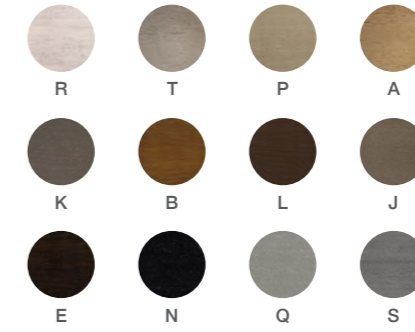

Front finish / Acabado frente

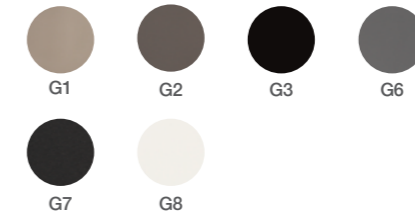

Pull / Tiradera

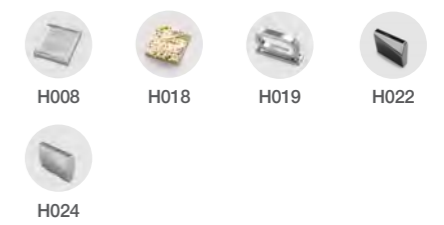

Product can be customized with or without pulls. / Producto puede personalizarse con o sin tiraderas.

Product can be customized with or without pulls. / Producto puede personalizarse con o sin tiraderas.

GEM NIGHTSTAND 210
velador gem 210

GM28-210

w 35^{1/2}" D 19^{3/4}" H 30"
90 cm 50 cm 76 cm

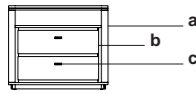
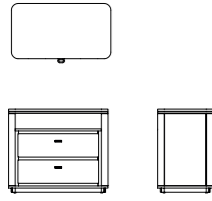

a:wood finish b:front finish c:pull

Front finish / Acabado frente
Wood finish / Acabado madera



Pull / Tiradera

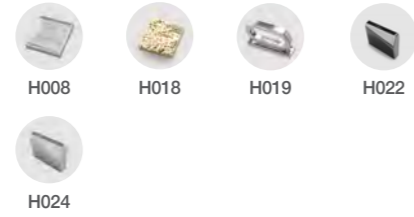

GEM NIGHTSTAND 211
(STONE TOP)
velador gem 211 (top piedra)

GM28-211

w 35^{1/2}" D 19^{3/4}" H 30"
90 cm 50 cm 76 cm

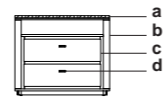
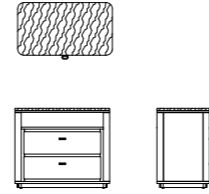

a:stone top b:wood finish c:front finish d:pull

Stone top / Top piedra

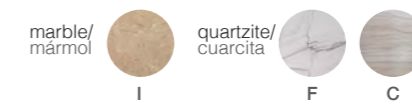

Pull / Tiradera

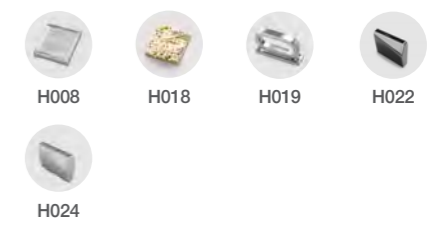

Front finish / Acabado frente
Wood finish / Acabado madera

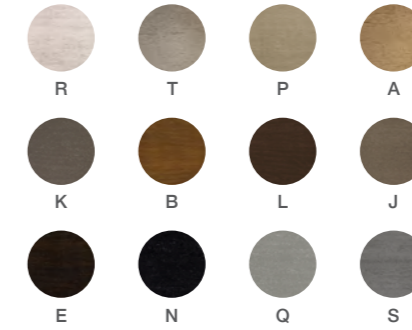

Product can be customized with or without pulls. / Producto puede personalizarse con o sin tiraderas.

Product can be customized with or without pulls. / Producto puede personalizarse con o sin tiraderas.

**GALAPAGOS
NIGHTSTAND 200**
velador galápagos 200

GS28-200*

w 29^{1/2}" d 21^{3/4}" h 25^{1/2}"
75 cm 55 cm 65 cm

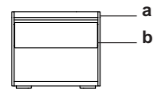
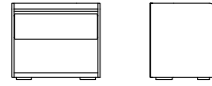
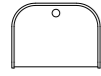

a: wood finish b: front finish

Front finish / Acabado frente
Wood finish / Acabado madera

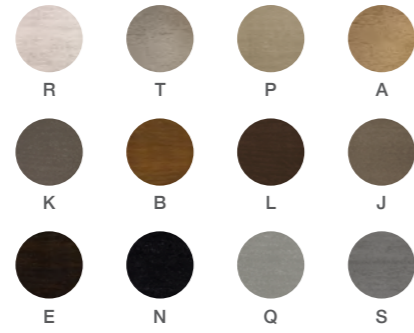

*Built-in electrical and USB connectivity. / Conectividad eléctrica y USB incorporada.



Referential photo. Some products, finishes or fabrics may no longer be available. /
Foto referencial. Algunos productos, acabados o telas podrían ya no estar disponibles.

**GALAPAGOS
NIGHTSTAND 210**
velador galápagos 210

GS28-210*

w 34" D 19^{3/4}" H 32"
86 cm 50 cm 81 cm

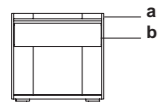
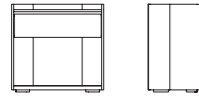
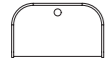

a:wood finish b:front finish

Front finish / Acabado frente
Wood finish / Acabado madera

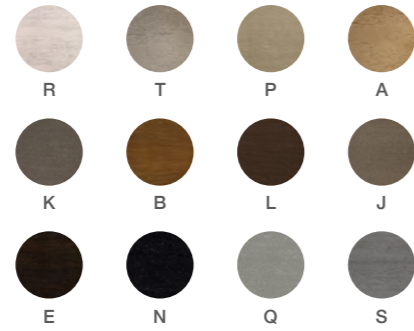

H NIGHTSTAND 100
velador h 100

HS28-100

w 23^{1/2}" D 16^{1/2}" H 19^{3/4}"
60 cm 42 cm 50 cm

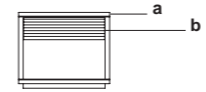
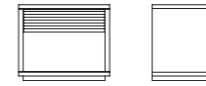

a:wood finish b:front finish

Front finish / Acabado frente
Wood finish / Acabado madera

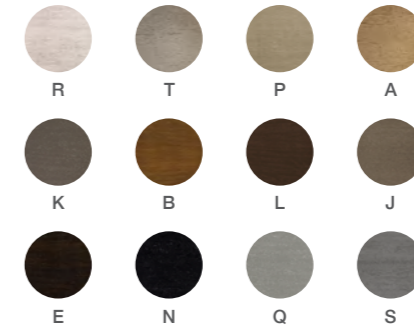

*Built-in electrical and USB connectivity. / Conectividad eléctrica y USB incorporada.

H NIGHTSTAND 200
velador h 200

HS28-200

w 23^{1/2}" D 17^{3/4}" H 23^{1/2}"
60 cm 45 cm 60 cm

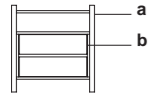
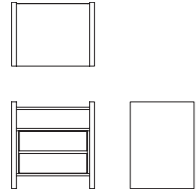

a:wood finish **b:**front finish

Front finish / Acabado frente
Wood finish / Acabado madera



H NIGHTSTAND 300
velador h 300

HS28-300

w 31^{1/2}" D 19^{3/4}" H 25^{1/2}"
80 cm 50 cm 65 cm

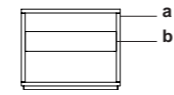
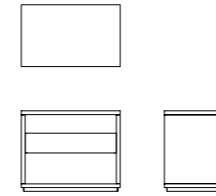

a:wood finish **b:**front finish

Front finish / Acabado frente
Wood finish / Acabado madera

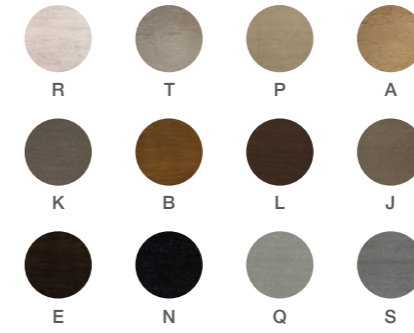

RUMBA NIGHTSTAND 100
velador rumba 100

RM28-100

w 33^{1/2"} D 20^{1/2"} H 25^{1/2"}
85 cm 52 cm 65 cm

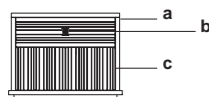
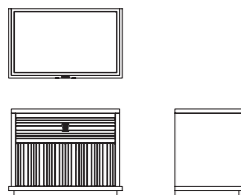

a: wood finish b: pull c: front finish

Front finish / Acabado frente
Wood finish / Acabado madera



Pull / Tiradera



Referential photo. Some products, finishes or fabrics may no longer be available. /
Foto referencial. Algunos productos, acabados o telas podrían ya no estar disponibles.

RUMBA NIGHTSTAND 210
velador rumba 210

RM28-210

w 36^{1/4}" D 20" H 32"
92 cm 51 cm 81 cm

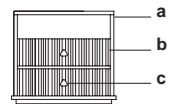
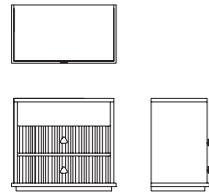

a: wood finish b: front finish c: pull

Front finish / Acabado frente
Wood finish / Acabado madera

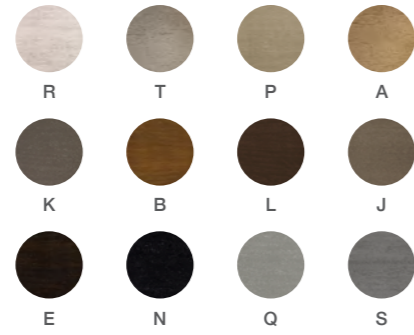

Pull / Tiradera



Referential photo. Some products, finishes or fabrics may no longer be available. /
Foto referencial. Algunos productos, acabados o telas podrían ya no estar disponibles.

RUMBA NIGHTSTAND 300
velador rumba 300

RM28-300

w 27^{1/2}" D 19^{3/4}" H 25^{1/2}"
70 cm 50 cm 65 cm

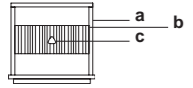
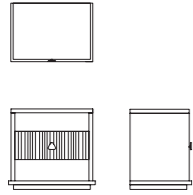

a:wood finish b:front finish c:pull

Front finish / Acabado frente
Wood finish / Acabado madera

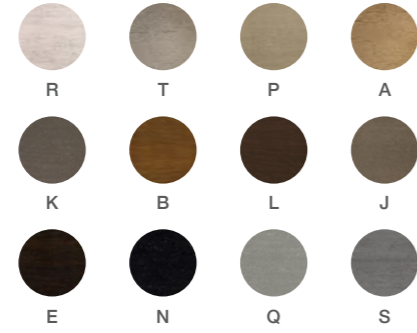

Pull / Tiradera



TEN NIGHTSTAND 201
(STONE TOP)
velador ten 201 (top piedra)

TN28-201

w 31^{1/2}" D 19^{3/4}" H 27^{1/2}"
80 cm 50 cm 70 cm

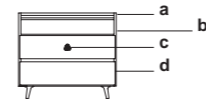
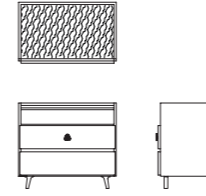

a:stone top b:wood finish c:pull d:front finish

Stone top / Top piedra

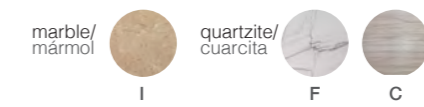

Pull / Tiradera

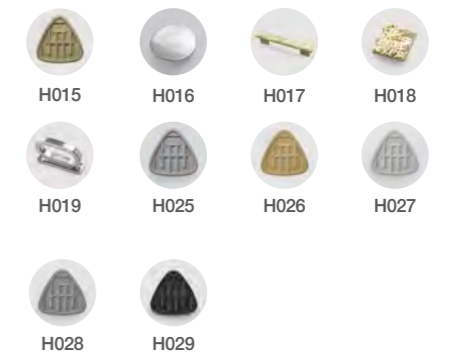

Front finish / Acabado frente
Wood finish / Acabado madera

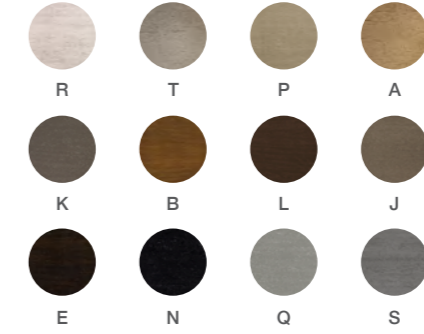

Product can be customized with or without pulls. / Producto puede personalizarse con o sin tiraderas.

DRESSERS

c ó m o d a s

DRESSERS

c ó m o d a s



BOLERO DRESSER 100
cómoda bolero 100



CAFE DRESSER 401
cómoda café 401



CAFE DRESSER 411
cómoda café 411



GALAPAGOS DRESSER 120
cómoda galapagos 120



GALAPAGOS DRESSER 121
cómoda galapagos 121



H DRESSER 200
cómoda h 200



CAFE DRESSER 420
cómoda café 420



GEM DRESSER 101
cómoda gem 101



GEM DRESSER 111
cómoda gem 111



RUMBA DRESSER 100
cómoda rumba 100



RUMBA DRESSER 300
cómoda rumba 300



TEN DRESSER 100
cómoda ten 100



GEM DRESSER 201
cómoda gem 201



GEM DRESSER 211
cómoda gem 211



GALAPAGOS DRESSER 100
cómoda galapagos 100

Slight color variations may occur while printing tear sheets due to printers pixelation and quality. Product specifications are subject to change due to product development updates. / Ligeras variaciones de color pueden ocurrir en la impresión. Las especificaciones están sujetas a cambios debido a las necesidades del producto.

Dimensions are usually approximated to the nearest quarter inch that will correspond to its metric conversion. / Las medidas generalmente se dan de acuerdo a la conversión métrica correspondiente y con una medida aproximada.

Slight color variations may occur while printing tear sheets due to printers pixelation and quality. Product specifications are subject to change due to product development updates. / Ligeras variaciones de color pueden ocurrir en la impresión. Las especificaciones están sujetas a cambios debido a las necesidades del producto.

Dimensions are usually approximated to the nearest quarter inch that will correspond to its metric conversion. / Las medidas generalmente se dan de acuerdo a la conversión métrica correspondiente y con una medida aproximada.

BOLERO DRESSER 100
(GLASS TOP)
 cómoda bolero 100
 (top vidrio)

BR29-100

w 59" D 19^{3/4}" H 31^{1/2}"
 150 cm 50 cm 80 cm

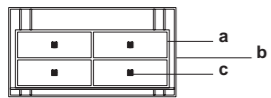
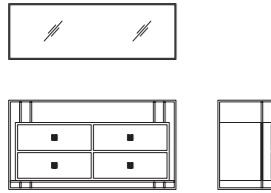

a:wood finish b:metal finish c:pull

Wood finish / Acabado madera



Metal finish / Acabado metal



Pull / Tiradera

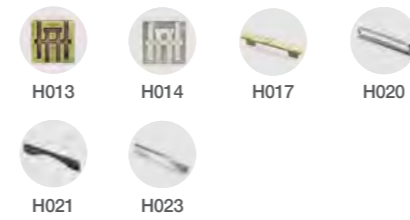

CAFE DRESSER 401
(STONE TOP)
 cómoda café 401
 (top piedra)

CF29-401

w 59" D 19^{3/4}" H 33"
 150 cm 50 cm 84 cm

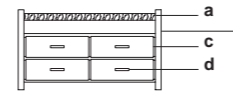
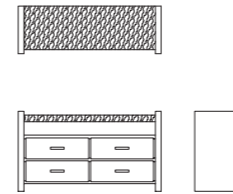

a:stone top b:wood finish c:front finish d:pull

Stone top / Top piedra

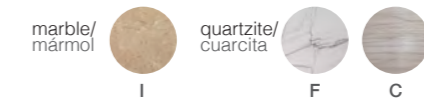

Wood finish / Acabado madera
 Front finish / Acabado frente

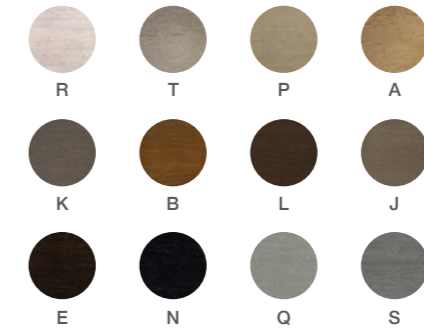

Pull / Tiradera

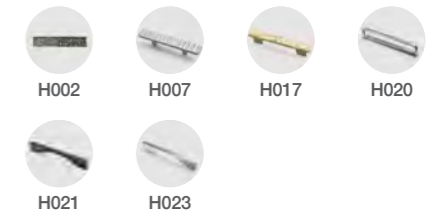

Glass Top included / Incluye top de vidrio

BEDROOM | DORMITORIO

Product can be customized with or without pulls. / Producto puede personalizarse con o sin tiraderas.

BEDROOM | DORMITORIO

CAFE DRESSER 411
(STONE TOP)
 cómoda café 411
 (top piedra)

CF29-411

w 59" D 19^{3/4}" H 33"
 150 cm 50 cm 84 cm

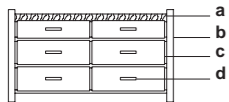
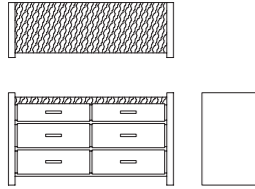

a:stone top b:wood finish c:front finish d:pull

Stone top / Top piedra



Pull / Tiradera



Wood finish / Acabado madera
 Front finish / Acabado frente

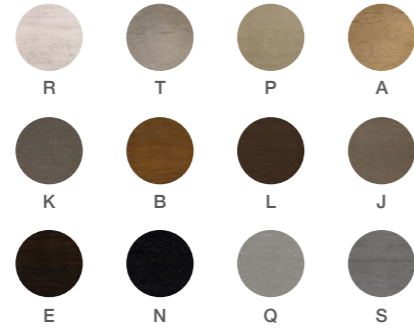

CAFE DRESSER 420
 cómoda café 420

CF29-420

w 80" D 20^{3/4}" H 36^{1/4}"
 203 cm 53 cm 92 cm

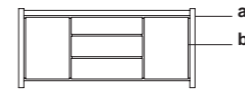
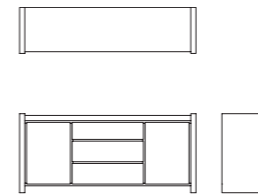

a:wood finish b:front finish

Wood finish / Acabado madera
 Front finish / Acabado frente

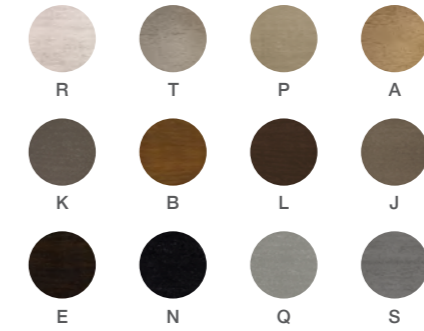

Pull / Tiradera



Product can be customized with or without pulls. / Producto puede personalizarse con o sin tiraderas.

Product can be customized with or without pulls. / Producto puede personalizarse con o sin tiraderas.

GEM DRESSER 101
(STONE TOP)
cómoda gem 101
(top piedra)

GM29-101

w 67" D 19^{3/4}" H 32^{1/4}"
170 cm 50 cm 82 cm

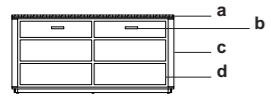
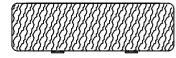

a:stone top b:pull c:wood finish d:front finish

Stone top / Top piedra

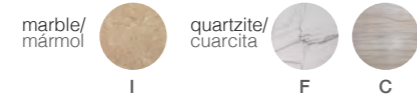

Pull / Tiradera

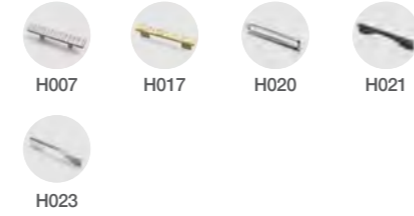

Wood finish / Acabado madera

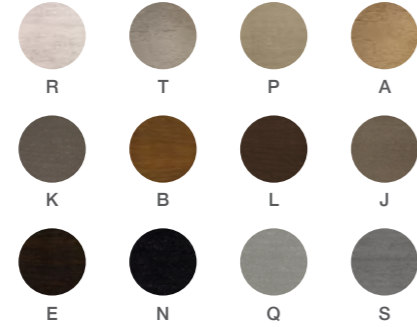

Front finish / Acabado frente



Product can be customized with or without pulls. / Producto puede personalizarse con o sin tiraderas.

GEM DRESSER 111
(STONE TOP)
cómoda gem 111
(top piedra)

GM29-111

w 67" D 19^{3/4}" H 32^{1/4}"
170 cm 50 cm 82 cm

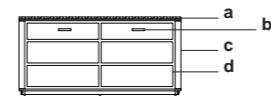
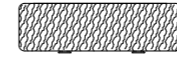

a:stone top b:pull c:wood finish d:front finish

Stone top / Top piedra



Pull / Tiradera

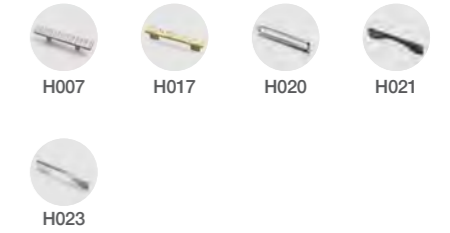

Wood finish / Acabado madera
Front finish / Acabado frente

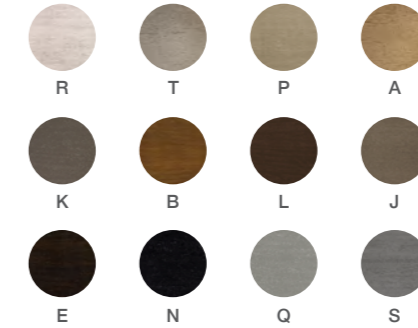

Product can be customized with or without pulls. / Producto puede personalizarse con o sin tiraderas.

GEM DRESSER 201
(STONE TOP)
 cómoda gem 201
 (top piedra)

GM29-201

w 80" D 19 3/4" H 32 1/4"
 203 cm 50 cm 82 cm

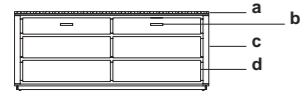
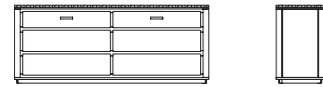
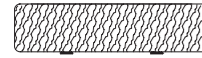

a:stone top b:pull c:wood finish d:front finish

Stone top / Top piedra



Pull / Tiradera

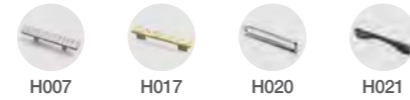

Wood finish / Acabado madera



Front finish / Acabado frente



Product can be customized with or without pulls. / Producto puede personalizarse con o sin tiraderas.

GEM DRESSER 211
(STONE TOP)
 cómoda gem 211
 (top piedra)

GM29-211

w 80" D 19 3/4" H 32 1/4"
 203 cm 50 cm 82 cm

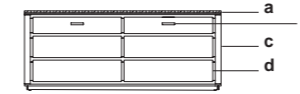
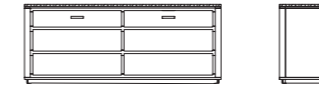
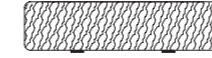

a:stone top b:pull c:wood finish d:front finish

Stone top / Top piedra



Pull / Tiradera

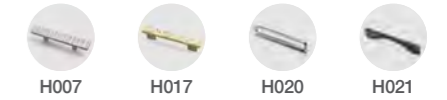

Wood finish / Acabado madera
 Front finish / Acabado frente

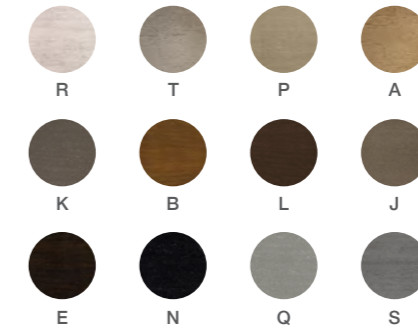

Product can be customized with or without pulls. / Producto puede personalizarse con o sin tiraderas.

GALAPAGOS DRESSER 100
cómoda galápagos100

GS29-100

w 59" d 21^{3/4}" h 33"
150 cm 55 cm 84 cm

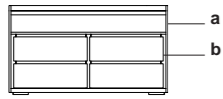
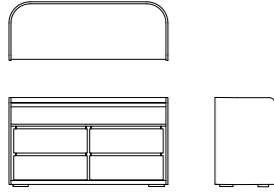

a:wood finish **b:**front finish

Wood finish / Acabado madera
Front finish / Acabado frente



Referential photo. Some products, finishes or fabrics may no longer be available. /
Foto referencial. Algunos productos, acabados o telas podrían ya no estar disponibles.

GALAPAGOS DRESSER 120
cómoda galápagos120

GS29-120

w 80" D 19^{3/4"} H 35"
203 cm 50 cm 89 cm

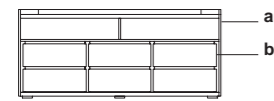
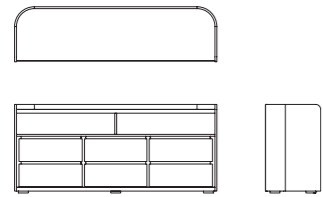

a:wood finish b:front finish

Wood finish / Acabado madera
Front finish / Acabado frente

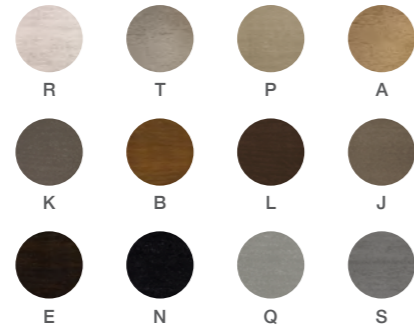

GALAPAGOS DRESSER 121 (STONE TOP)
cómoda galápagos121
(stone top)

GS29-121

w 80" D 19^{3/4"} H 35"
203 cm 50 cm 89 cm

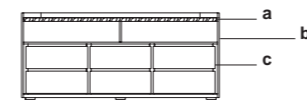
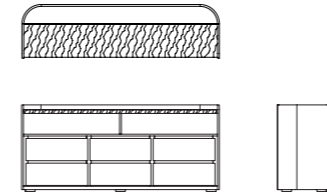

a:stone top b:wood finish c:front finish

Stone top / Top piedra

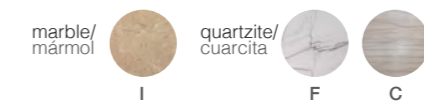

Wood finish / Acabado madera
Front finish / Acabado frente

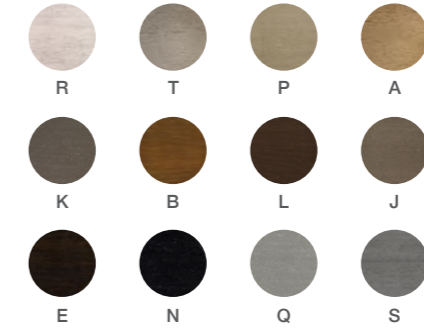

H DRESSER 200
cómoda h 200

HS29-200

w 59" D 19 3/4" H 33"
150 cm 50 cm 84 cm

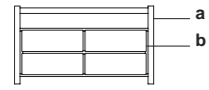
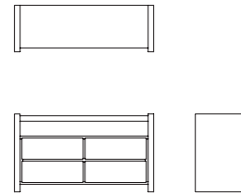

a: wood finish **b**: front finish

Wood finish / Acabado madera
Front finish / Acabado frente



RUMBA DRESSER 100
cómoda rumba 100

RM29-100

w 63 3/4" D 20 1/2" H 31 1/2"
162 cm 52 cm 80 cm

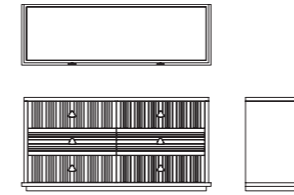

a: wood finish **b**: hardware **c**: front finish

Wood finish / Acabado madera
Front finish / Acabado frente

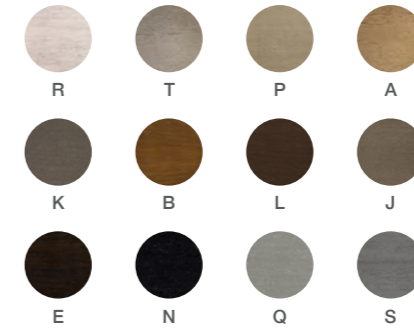

Hardware / Herraje

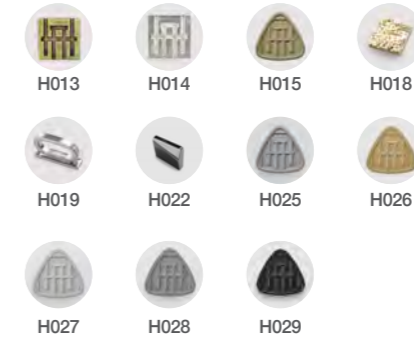

RUMBA DRESSER 300
cómoda rumba 300

RM29-300

w 80" D 20 1/2" H 36 1/4"
203 cm 52 cm 92 cm

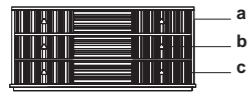

a: wood finish b: hardware c: front finish

Wood finish / Acabado madera
Front finish / Acabado frente



Hardware / Herraje

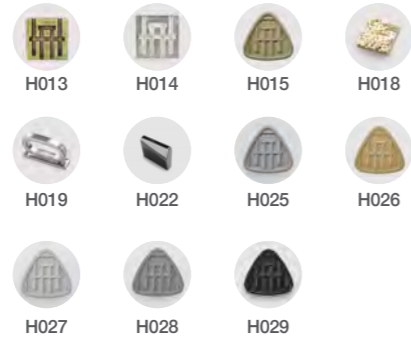

TEN DRESSER 100
(LEATHER TOP)
cómoda ten 100 (top cuero)

TN29-100

w 67" D 19 3/4" H 33"
170 cm 50 cm 84 cm

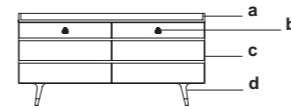
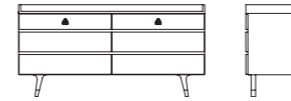

a: leather top b: pull c: front finish d: wood finish

Leather top / top cuero



Pull / Tiradera

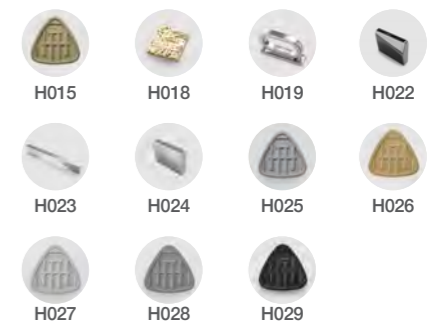

Wood finish / Acabado madera
Front finish / Acabado frente



OCCASIONAL PIECES | PIEZAS OCASIONALES



ENTERTAINMENTS

centros de entretenimiento



BOLERO ENTERTAINMENT 200
entertainment bolero 200



GRAFITO ENTERTAINMENT 100
entertainment grafito 100



GRAFITO ENTERTAINMENT 110
entertainment grafito 110



RUMBA CREDENZA 200
credenza rumba 200

BOLERO ENTERTAINMENT 200

entertainment bolero 200

BR30-200

w 63" D 15^{3/4}" H 27^{1/2}"
160 cm 40 cm 70 cm

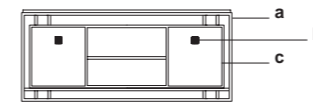
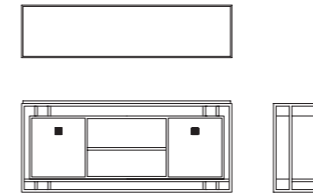

a:metal finish b:pull c:wood finish

Wood finish / Acabado madera

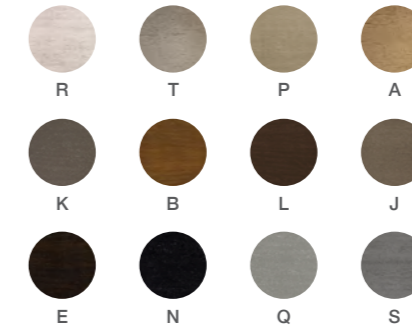

Metal finish / Acabado metal



Pull / Tiraderas

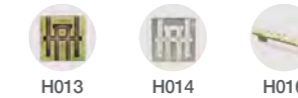

Slight color variations may occur while printing tear sheets due to printers pixelation and quality. Product specifications are subject to change due to product development updates. / Ligeras variaciones de color pueden ocurrir en la impresión. Las especificaciones están sujetas a cambios debido a las necesidades del producto.

Dimensions are usually approximated to the nearest quarter inch that will correspond to its metric conversion. / Las medidas generalmente se dan de acuerdo a la conversión métrica correspondiente y con una medida aproximada.

GRAFITO
ENTERTAINMENT 100
entertainment grafito 100

GT34-100

w 76" D 20 3/4" H 23 1/2"
193 cm 53 cm 60 cm

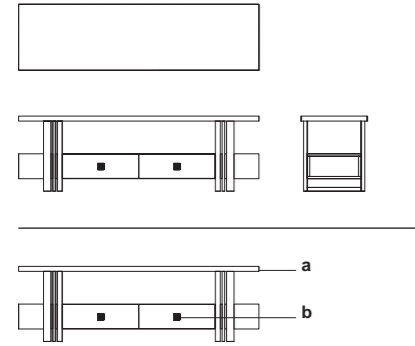

a:wood finish b:pull

Wood finish / Acabado madera

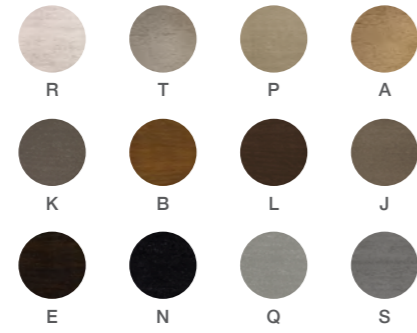

Pull / Tiradera

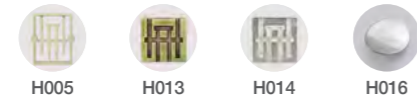

GRAFITO
ENTERTAINMENT 110
entertainment grafito 110

GT34-110

w 76" D 20 3/4" H 23 1/2"
193 cm 53 cm 60 cm

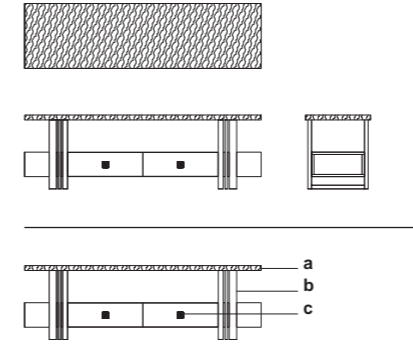

a:stone top a:wood finish b:pull

Stone top / Top piedra



Wood finish / Acabado madera

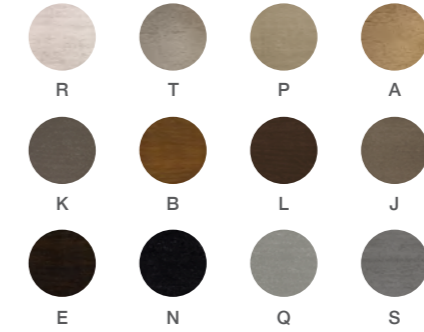

Pull / Tiradera

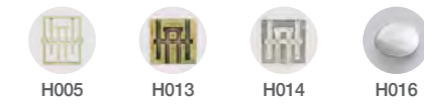

RUMBA CREDENZA 200
credenza rumba 200

RM07-200

w 78^{3/4"} D 15^{3/4"} H 23^{1/2"}
200 cm 40 cm 60 cm

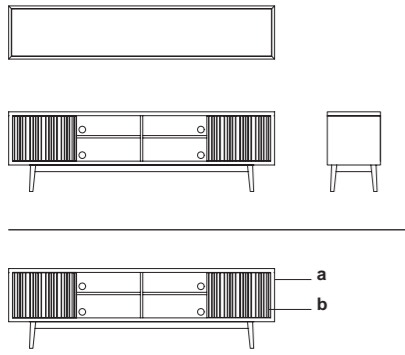

a: wood finish **b:** front finish

Wood finish / Acabado madera
Front finish / Acabado frente

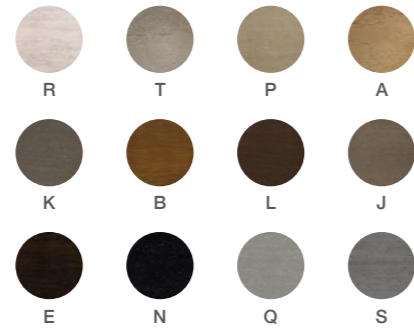

Referential photo. Some products, finishes or fabrics may no longer be available. /
Foto referencial. Algunos productos, acabados o telas podrían ya no estar disponibles.

BOOKCASES & DESKS

libreros y escritorios



BOLERO BOOKCASE 200
librero bolero 200



BOLERO BOOKCASE 210
librero bolero 210



CAFE BOOKCASE 400
librero café 400



CHOCOLATE DESK 200
escritorio chocolate 200



GALAPAGOS DESK 100
escritorio galapagos 100



GRAFITO DESK 102
escritorio grafito 102



H DESK 100
escritorio h 100



H DESK 110
escritorio h 110



TEN DESK 200
escritorio ten 200



TEN DESK 210
escritorio ten 210

Slight color variations may occur while printing tear sheets due to printers pixelation and quality. Product specifications are subject to change due to product development updates. / Ligeras variaciones de color pueden ocurrir en la impresión. Las especificaciones están sujetas a cambios debido a las necesidades del producto.

Dimensions are usually approximated to the nearest quarter inch that will correspond to its metric conversion. / Las medidas generalmente se dan de acuerdo a la conversión métrica correspondiente y con una medida aproximada.

BOLERO BOOKCASE 200
librero bolero 200

BR33-200

w 31^{1/2}" D 15^{3/4}" H 82^{3/4}"
80 cm 40 cm 210 cm

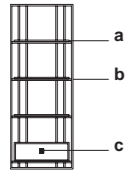

a:wood finish b:metal finish c:pull

Wood finish / Acabado madera

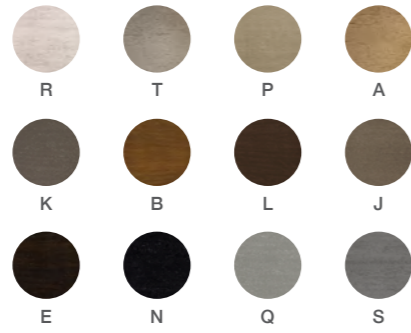

Metal finish / Acabado metal



Pull / Tiradera

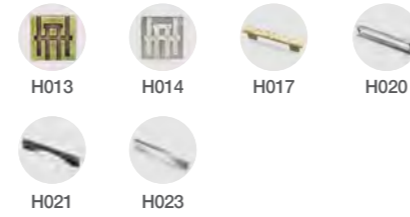

BOLERO BOOKCASE 210
librero bolero 210

BR33-210

w 31^{1/2}" D 15^{3/4}" H 82^{3/4}"
80 cm 40 cm 210 cm

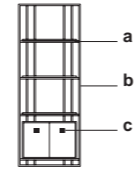
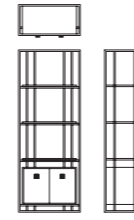

a:wood finish b:metal finish c:pull

Wood finish / Acabado madera



Metal finish / Acabado metal



Pull / Tiradera

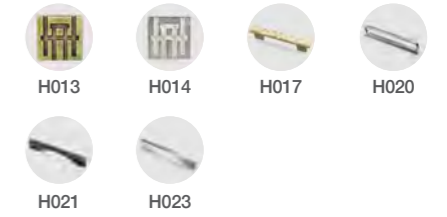

CAFE BOOKCASE 400
(2 PIECES)
librero café 400 (2 piezas)

CF33-400

w 57" D 13 3/4" H 82 3/4"
145 cm 35 cm 210 cm

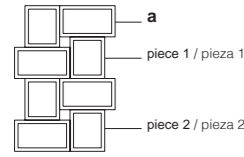
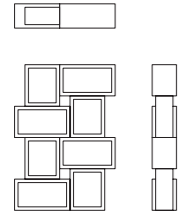

a: wood finish

Wood finish / Acabado madera

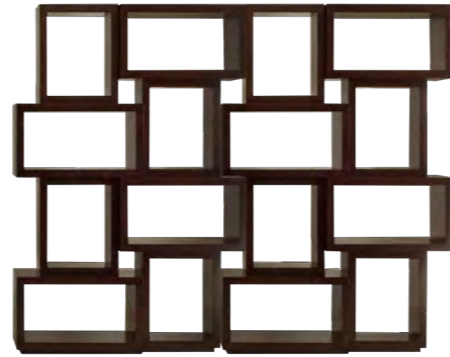

This piece can be assembled horizontally or vertically. /
Esta pieza puede ser ensamblada de manera horizontal o vertical.

CHOCOLATE DESK 200
escritorio chocolate 200

CH36-200*

w 70 3/4" D 63" H 29 1/2"
180 cm 160 cm 75 cm

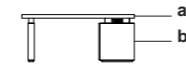
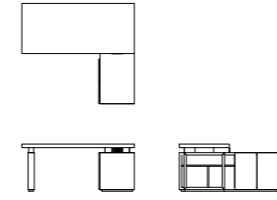

a: top finish b: wood finish

Top finish / Acabado top
Base finish / Acabado base

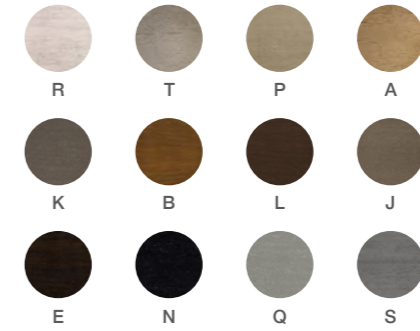

*Built-in electrical and USB connectivity. / Conectividad eléctrica y USB incorporada.

GALAPAGOS DESK 100
escritorio galápagos 100

GS36-100*

w 63" D 25 1/2" H 31 1/2"
160 cm 65 cm 80 cm

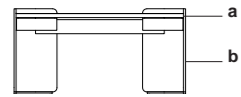
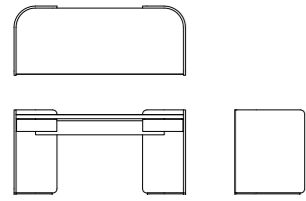

a:top finish b:wood finish

Top finish / Acabado top
Base finish / Acabado base

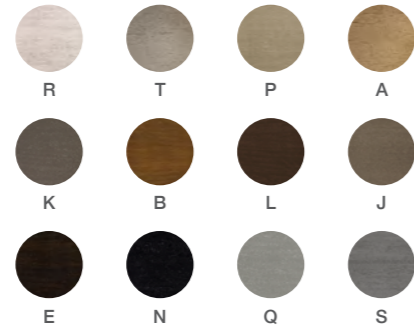

*Built-in electrical and USB connectivity. / Conectividad eléctrica y USB incorporada.

GRAFITO DESK 102
escritorio grafito 102

GT36-102

w 63" D 25 1/2" H 30"
160 cm 65 cm 76 cm

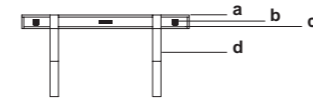
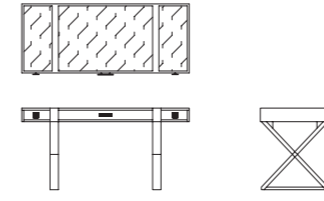

a:leather top b:pull c:leather detail d:wood finish



Leather top / Top cuero*
Leather Detail / Detalle cuero*



Pull / Tiradera



*The leathers are applicable only in specific details /
Estos cueros son aplicables únicamente en detalles específicos

Wood finish / Acabado madera

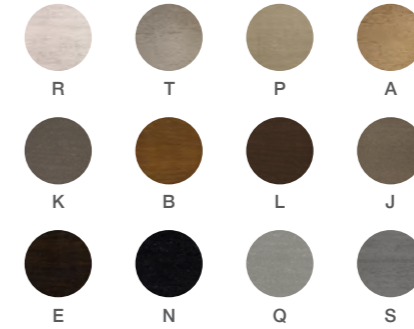

H DESK 100
escritorio H 100

HS36-100

w 55" d 21^{3/4}" H 30"
140 cm 55 cm 76 cm

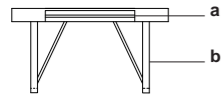
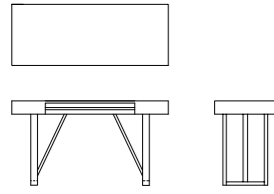

a:front finish **b**:wood finish

Front finish / Acabado frente
Wood finish / Acabado madera

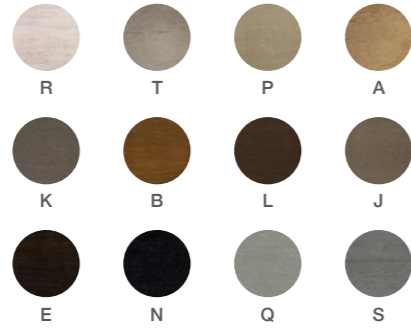

H DESK 110
escritorio H 110

HS36-110

w 43^{1/4}" d 21^{3/4}" H 30"
110 cm 55 cm 76 cm

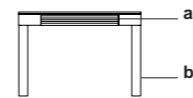
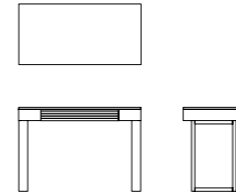

a:front finish **b**:wood finish

Front finish / Acabado frente
Wood finish / Acabado madera

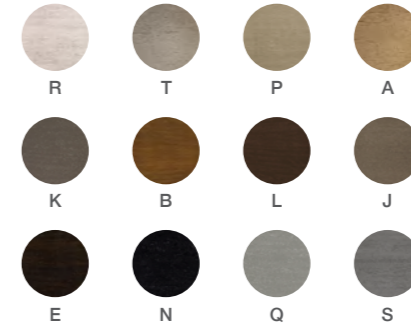

TEN DESK 200
escritorio ten 200

TN36-200*

w 70^{3/4"} d 31^{1/2"} H 29^{1/2"}
180 cm 80 cm 75 cm

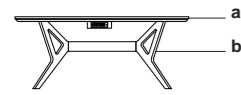
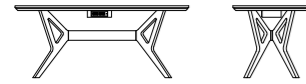
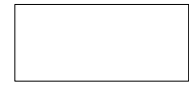

a:top finish **b**:base finish

Top finish / Acabado top
Base finish / Acabado base

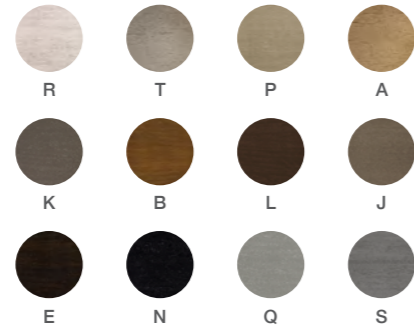

TEN DESK 210
escritorio ten 210

TN36-210*

w 70^{3/4"} d 31^{1/2"} H 29^{1/2"}
180 cm 80 cm 75 cm

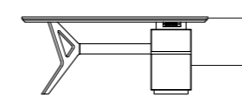

a:top finish **b**:base finish

Top finish / Acabado top
Base finish / Acabado base

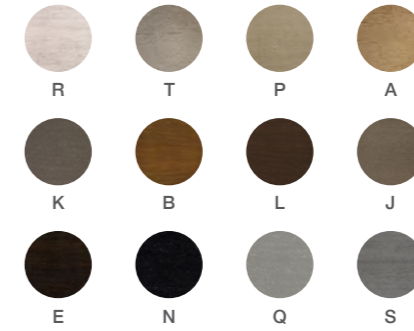

*Built-in electrical and USB connectivity. / Conectividad eléctrica y USB incorporada.

*Built-in electrical and USB connectivity. / Conectividad eléctrica y USB incorporada.

ACCENT PIECES

piezas de acento



CAFE HALL TABLE 400
mesa de hall café 400



GALAPAGOS HALL TABLE 100
mesa hall galápagos 100



GALAPAGOS HALL TABLE 200
mesa hall galápagos 200



BOLERO BAR 100
bar bolero 100



BOLERO BAR 200
bar bolero 200

Slight color variations may occur while printing tear sheets due to printers pixelation and quality. Product specifications are subject to change due to product development updates. / Ligeras variaciones de color pueden ocurrir en la impresión. Las especificaciones están sujetas a cambios debido a las necesidades del producto.

Dimensions are usually approximated to the nearest quarter inch that will correspond to its metric conversion. / Las medidas generalmente se dan de acuerdo a la conversión métrica correspondiente y con una medida aproximada.

**CAFE HALL TABLE
BASE 400**
base mesa de hall café 400

CF25-400

DIAM. 35^{1/2}" H 28^{3/4}"
90 cm 73 cm

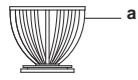

a:wood finish

GLASS TOP / TOP DE VIDRIO

VN056

DIAM. 63" H 3/4"
160 cm 1,9 cm

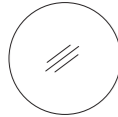

**CAFE HALL TABLE 410
(GLASS TOP)**
mesa de hall café 410
(top vidrio)

CF25-410*

DIAM. 63" H 29^{1/2}"
160 cm 75 cm

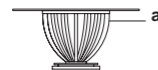
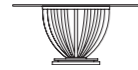
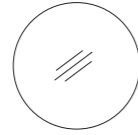

a:wood finish

*SKU valid only for Ecuador
*SKU válido únicamente para Ecuador

Wood finish / Acabado madera

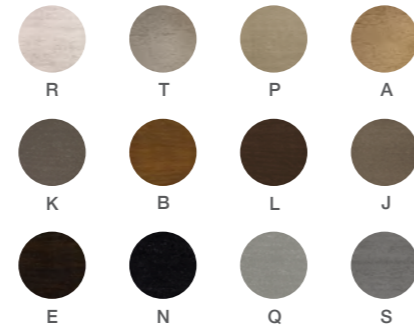

**GALAPAGOS HALL
TABLE BASE 100**
base mesa de hall
galápagos 100

GS25-100

DIAM. 39^{1/4}" H 28^{3/4}"
100 cm 73 cm

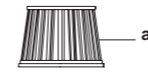

a:wood finish

GLASS TOP / TOP DE VIDRIO

VN056

DIAM. 63" H 3/4"
160 cm 1,9 cm



**GALAPAGOS HALL
TABLE 110 (GLASS TOP)**
mesa hall galápagos 110
(top vidrio)

GS25-110*

DIAM. 63" H 29^{1/2}"
160 cm 75 cm

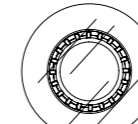

a:wood finish

*SKU valid only for Ecuador
*SKU válido únicamente para Ecuador

Wood finish / Acabado madera

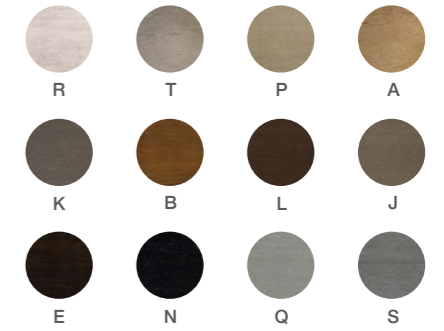

GALAPAGOS
HALL TABLE 200
mesa de hall galápagos 200

GS25-200

DIAM. 59^{3/4}" H 30"
152 cm 76 cm

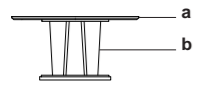
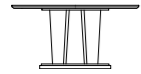
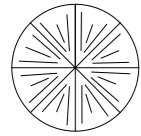

a:top finish **b**:base finish

Top finish / Acabado top
Base finish / Acabado base



BOLERO BAR 100
bar bolero 100

BR24-100

w 35^{1/2}" D 19^{3/4}" H 67"
90 cm 50 cm 170 cm

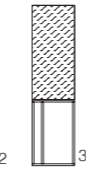
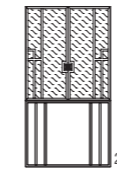
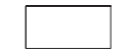

Exterior view 1: plan 2: front 3: side
Vista externa 1: superior 2: frontal 3: lateral

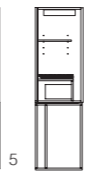
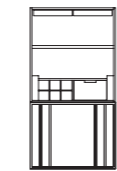
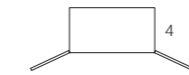

Interior view 4: plan 5: front 6: side
Vista interna 4: superior 5: frontal 6: lateral

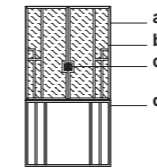

a:wood finish **b**:door insert **c**:pull **d**:metal finish



Wood finish / Acabado madera

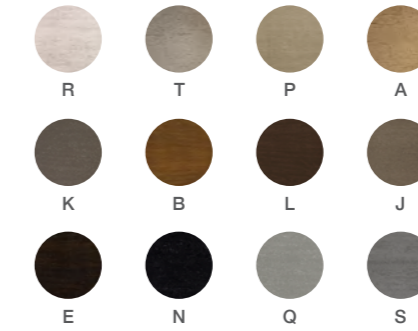

Door insert / Inserto puerta



Metal finish / Acabado metal



Pull / Tiradera



H013

H014



BOLERO BAR 200
bar bolero 200

BR24-200

W 55" D 27 1/2" H 43 1/4"
140 cm 70 cm 110 cm

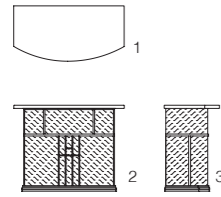

Exterior view 1: top 2: front 3: side
Vista externa 1: superior 2: frontal 3: lateral

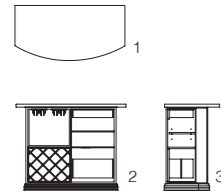

Interior view 4: top 5: front 6: side
Vista interna 4: superior 5: frontal 6: lateral

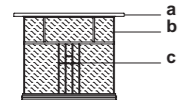

a: wood finish b: leather detail c: metal finish

Wood finish / Acabado madera



Leather detail / Detalle cuero

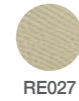

Metal finish / Acabado metal



Pull / Tiradera

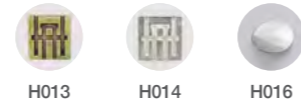

MIRRORS
espejos

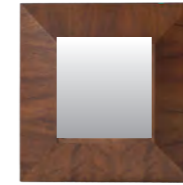

CARAMELO MIRROR 700
espejo caramelo 700



GRAFITO MIRROR 100
espejo grafito 100



GRAFITO MIRROR 110
espejo grafito 110



GRAFITO MIRROR 120
espejo grafito 120

Slight color variations may occur while printing tear sheets due to printers pixelation and quality. Product specifications are subject to change due to product development updates. / Ligeras variaciones de color pueden ocurrir en la impresión. Las especificaciones están sujetas a cambios debido a las necesidades del producto.

Dimensions are usually approximated to the nearest quarter inch that will correspond to its metric conversion. / Las medidas generalmente se dan de acuerdo a la conversión métrica correspondiente y con una medida aproximada.

CARAMELO MIRROR 700
espejo caramelo 700

CM35-700

w 23 1/2" D 2 1/4" H 23 1/2"
60 cm 6 cm 60 cm

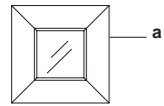
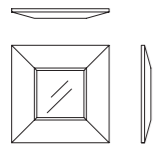

a: wood finish

Wood finish / Acabado madera



GRAFITO MIRROR 100
espejo grafito 100

GT35-100

w 27 1/2" D 1 1/4" H 27 1/2"
70 cm 3 cm 70 cm

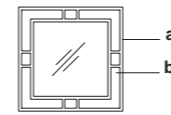
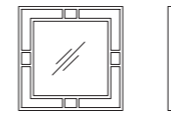

a: wood finish b: leather detail

Wood finish / Acabado madera

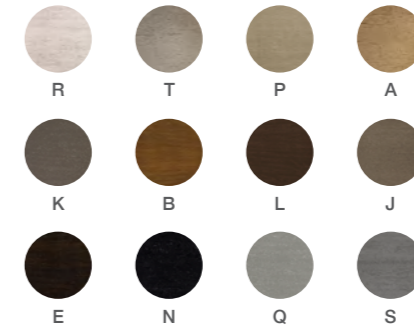

Leather detail / Detalle cuero



RE027



GRAFITO MIRROR 110
espejo grafito 110

GT35-110

w 63" D 1 1/4" H 35 1/2"
160 cm 3 cm 90 cm

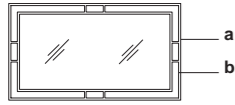
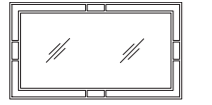

a:wood finish b:leather detail

Wood finish / Acabado madera

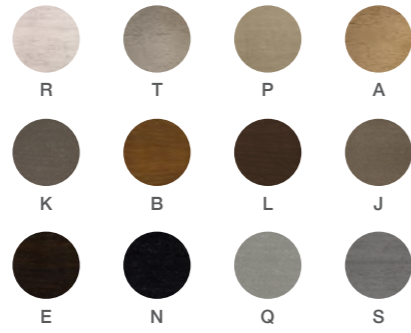

Leather detail / Detalle cuero



RE027



GRAFITO MIRROR 120
espejo grafito 120

GT35-120

w 31 1/2" D 1 1/4" H 70 3/4"
80 cm 3 cm 180 cm

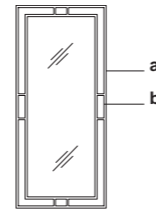
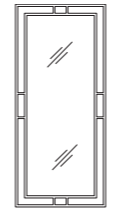

a:wood finish b:leather detail

Wood finish / Acabado madera

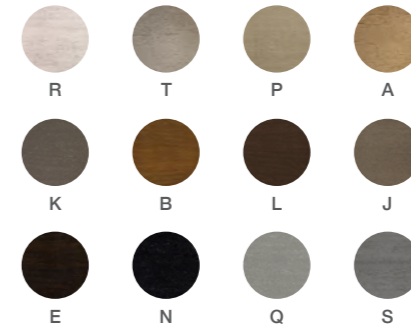

Leather detail / Detalle cuero



RE027

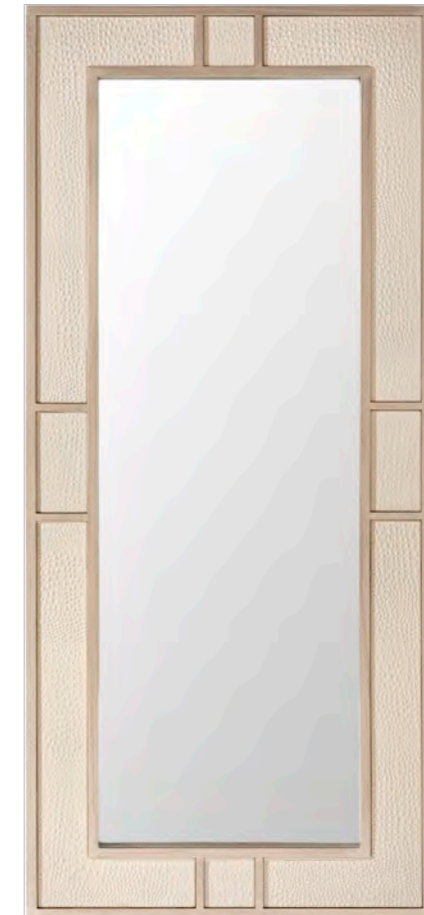

WOOD FINISHES

acabados de madera



R ARENA

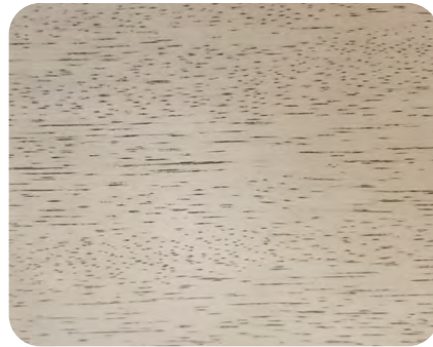

T TAUPE



P CHAMPAGNE



A NATURAL



K MINK

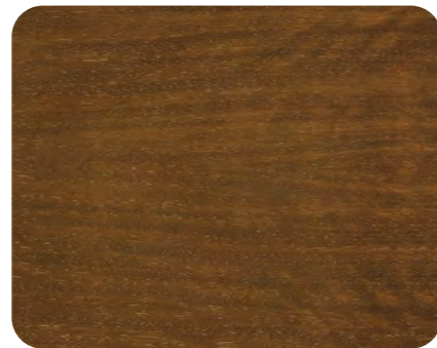

B BAHIA



L PALMA



J JAMA

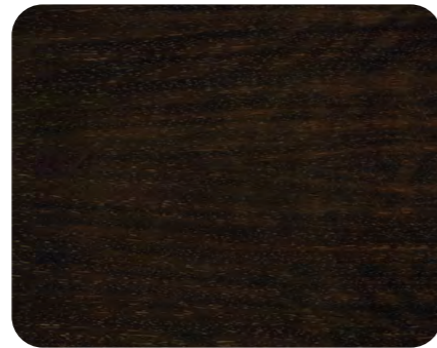

E ESPRESSO

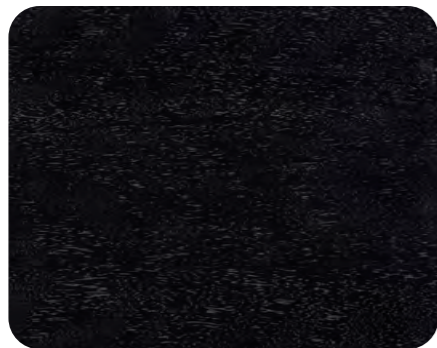

N CHARCOAL



Q PLATINUM



S ASH GREY

HIGH GLOSS FINISHES

acabados high gloss

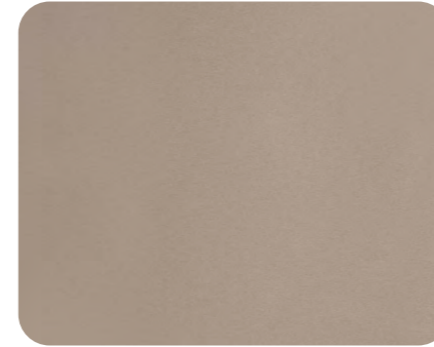

G1 CHAMPAGNE HIGH GLOSS



G2 MINK HIGH GLOSS



G3 GRAFITO HIGH GLOSS

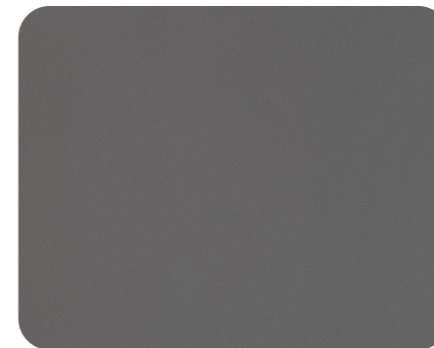

G6 PLATINUM HIGH GLOSS

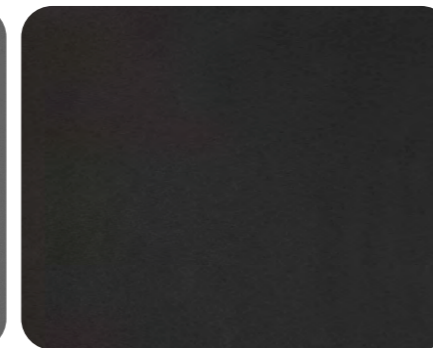

G7 GUN METAL HIGH GLOSS

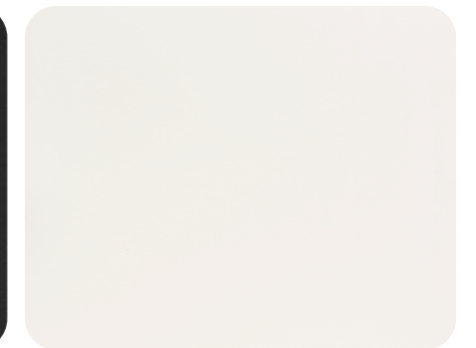

G8 OFF WHITE HIGH GLOSS

Slight color variations may occur while printing tear sheets due to printers pixelation and quality / Ligeras variaciones de color pueden ocurrir en la impresión.

Slight color variations may occur while printing tear sheets due to printers pixelation and quality / Ligeras variaciones de color pueden ocurrir en la impresión.

DEKTON

dekton



B BERGEN



H KHALO



T TAGA

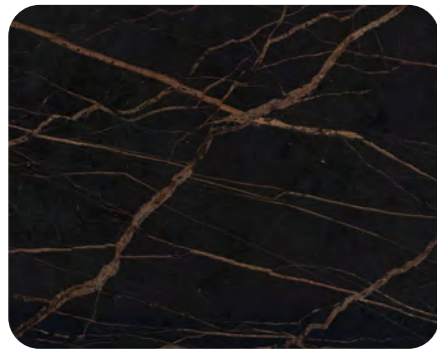

U LAURENT

PORCELAIN*

Porcelanato*



A CALACATTA WHITE

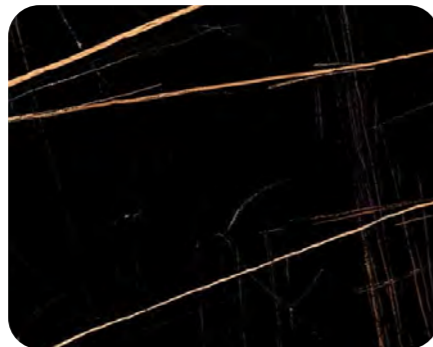

S BLACK SAINT

*Only available on specific H Collection products. / Disponible únicamente para productos específicos de la Colección H.

MARBLE

mármol



I IVORY

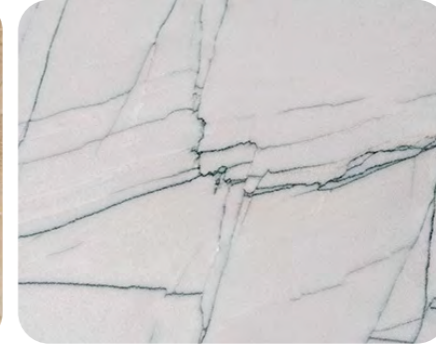

F WHITE FOG



C MOCCA

METAL FINISHES

acabados de metal



W1 BRONZE

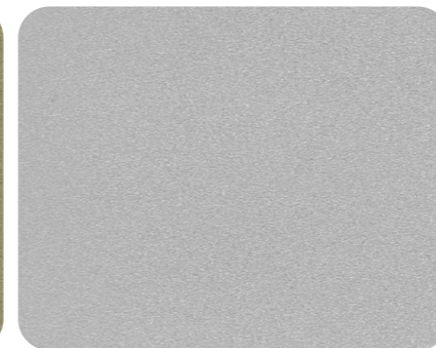

W2 SILVER

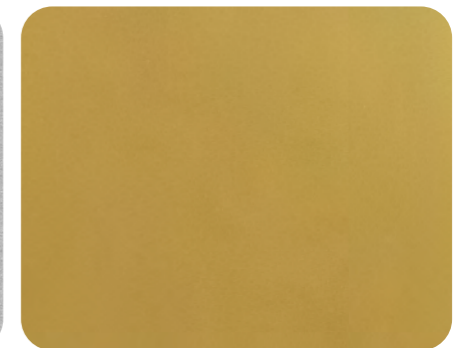

W4 SATIN GOLD

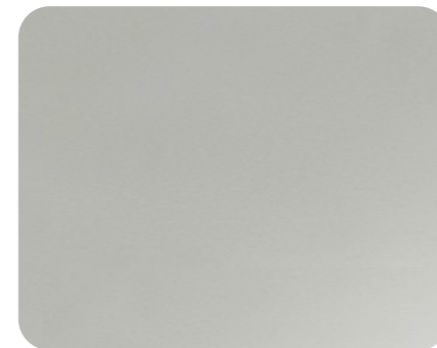

W5 CHROME

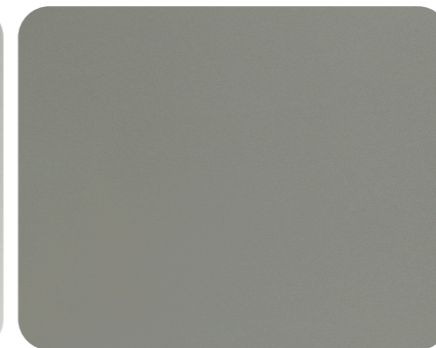

W6 PLATINUM

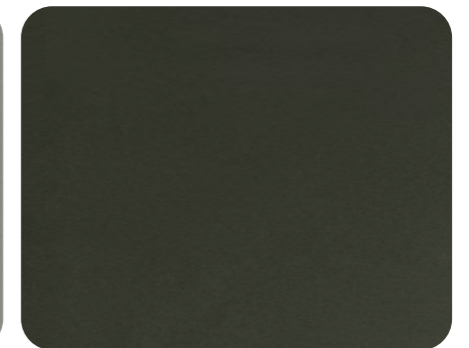

W7 GUN METAL

Slight color variations may occur while printing tear sheets due to printers pixelation and quality / Ligeras variaciones de color pueden ocurrir en la impresión.

LEATHER OPTIONS

opciones de cuero



RE027 BEIGE ASPEN



1-CR002 OYSTER MILAN PORTOFINO



RE045 BROWN MILAN PORTOFINO



RE049 CAMEL MILAN PORTOFINO



RE057 WHITE MILAN PORTOFINO



RE061 LIGHT GRAY MILAN PORTOFINO



RE064 SILVER GRAY MILAN PORTOFINO



RE069 LIGHT CAMEL MILAN PORTOFINO

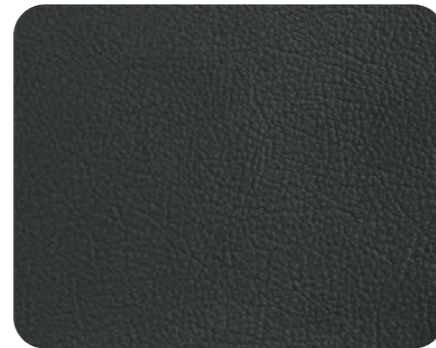

RE070 GUN METAL MILAN PORTOFINO

The leathers are applicable only in specific details / Estos cueros son aplicables unicamente en detalles especificos
Slight color variations may occur while printing tear sheets due to printers pixelation and quality / Ligeras variaciones de color pueden ocurrir en la impresión.

LEATHER OPTIONS

opciones de cuero



RE071 OLIVE GREEN MILAN PORTOFINO



RE072 OFF WHITE MILAN PORTOFINO

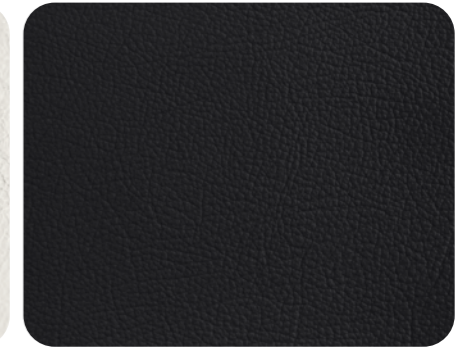

RE073 PURE BLACK MILAN PORTOFINO

The leathers are applicable only in specific details / Estos cueros son aplicables unicamente en detalles especificos
Slight color variations may occur while printing tear sheets due to printers pixelation and quality / Ligeras variaciones de color pueden ocurrir en la impresión.

DECORATIVE HARDWARE
herraje decorativo



H-011

H-012

H-015



H-025

H-026

H-027



H-028

H-029

PULL
tiraderas



H-001

H-002

H-005

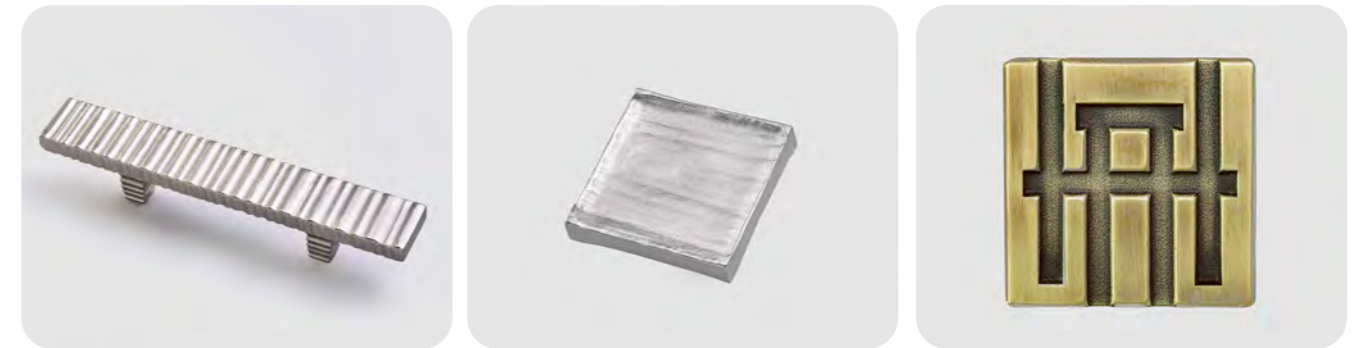

H-007

H-008

H-013



H-014

H-015

H-016



H-017

H-018

H-019

Slight color variations may occur while printing tear sheets due to printers pixelation and quality / Ligeras variaciones de color pueden ocurrir en la impresión.

Slight color variations may occur while printing tear sheets due to printers pixelation and quality / Ligeras variaciones de color pueden ocurrir en la impresión.

PULL
tiraderas



H-020



H-021



H-022



H-023



H-024



H-025



H-026



H-027

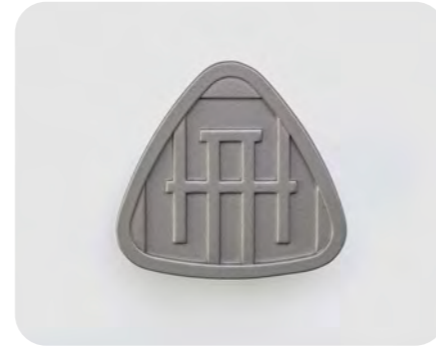

H-028



H-029

METALLIC BUTTONS
botones metálicos



GOLD



CHROME

DECORATIVE PLATES
placas decorativas



BRONZE



SILVER

MIRRORS
espejos

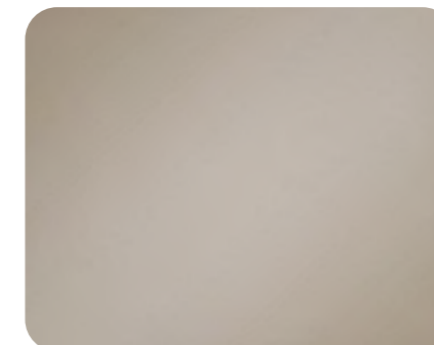

BRONZE



FUME

Slight color variations may occur while printing tear sheets due to printers pixelation and quality / Ligeras variaciones de color pueden ocurrir en la impresión.

Slight color variations may occur while printing tear sheets due to printers pixelation and quality / Ligeras variaciones de color pueden ocurrir en la impresión.

Slight color variations may occur while printing tear sheets due to printers pixelation and quality. Product specifications are subject to change due to product development updates.

Ligeras variaciones de color pueden ocurrir en la impresión. Las especificaciones están sujetas a cambios debido a las necesidades del producto.

Dimensions are usually approximated to the nearest quarter inch that will correspond to its metric conversion.

Las medidas generalmente se dan de acuerdo a la conversión métrica correspondiente y con una medida aproximada.

Not all the products shown in the renderings or photos are available.

No todos los productos que aparecen en las fotografías o renders están disponibles. Please refer

FABRIC COLLECTIONS COLECCIÓN DE TELAS

Please refer to the AH fabric collection for upholstery specifications.

Para propósito de tapicería consultar la Colección de Telas AH vigente.

www.adrianahoyos.com

ALL ADRIANA HOYOS DESIGNS ARE PROTECTED BY COPYRIGHT © UNDER ADRIANA HOYOS FURNISHING

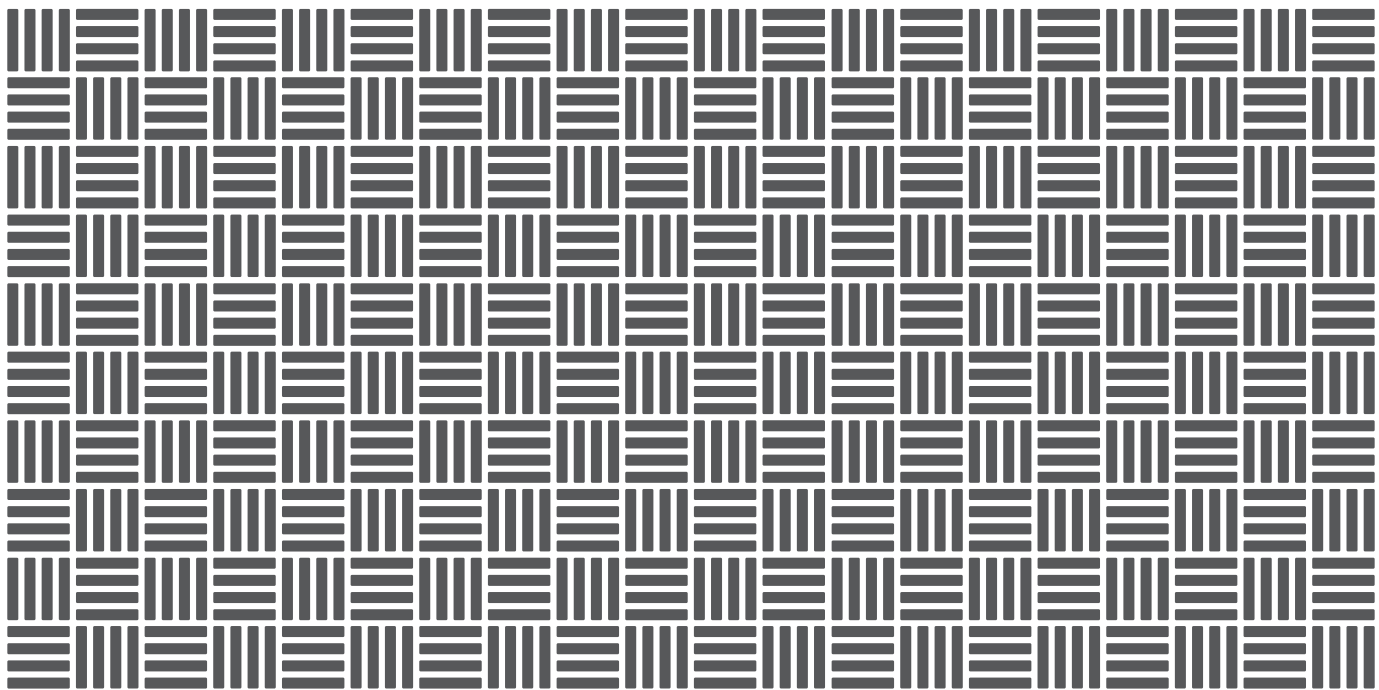
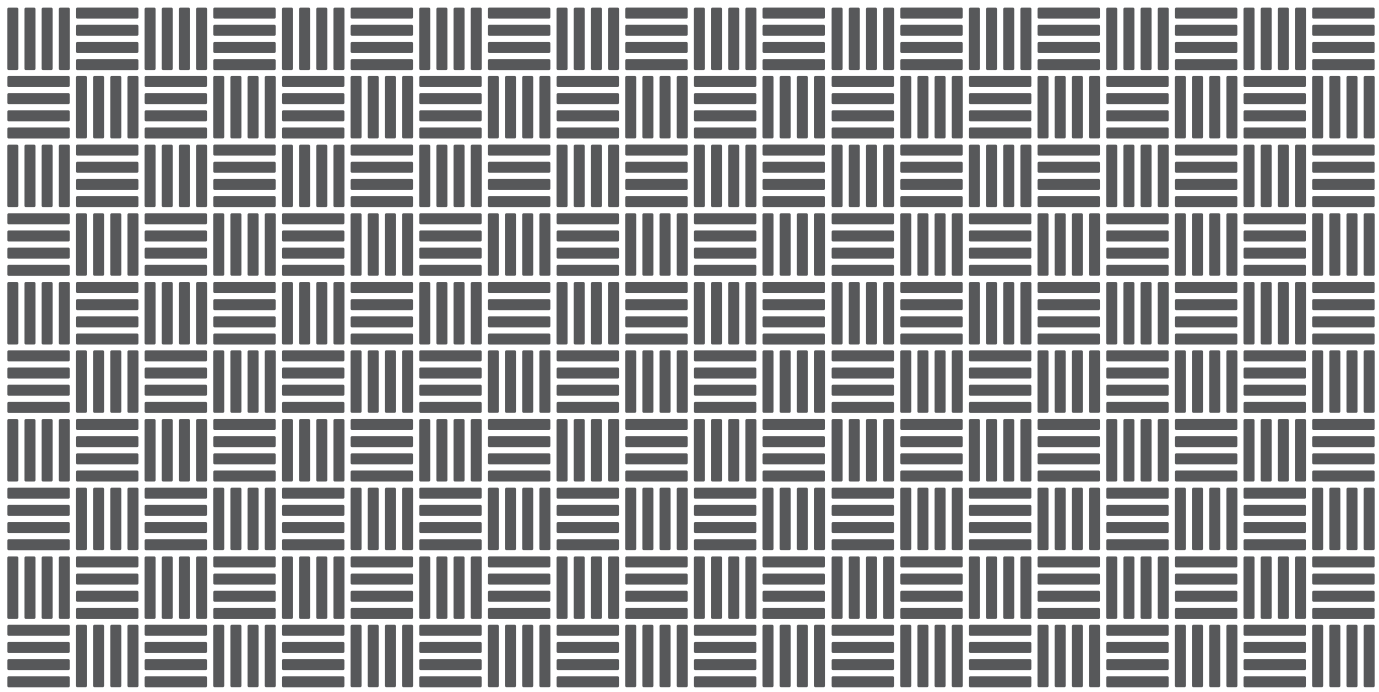

www.adrianahoyos.com

NORTH AMERICA | SOUTH AMERICA | CENTRAL AMERICA | EUROPE | UNITED ARAB EMIRATES